



# **LEWIS POULTRY HOUSEKEEPER OWNER / OPERATOR MANUAL**



**MODEL # HK-3.5      HOUSEKEEPER**

**FROM:      SERIAL # 9419**

Manufactured by:

**LEWIS BROTHERS MANUFACTURING, INC.**

Post Office Box 146

Baxley, GA 31513

Tel: (912) 367-4651

Fax: (912) 367-3958

10-19-2021

# INTRODUCTION

All Lewis Brothers equipment is manufactured under stringent production and quality assurance procedures prior to preparation for shipment. A final quality check is performed on all equipment before shipping.

The best equipment is only as good as its operation and management. Sound operation and good preventive maintenance practices are essential to efficient performance of your Lewis Poultry Housekeeper.

Questions on parts and service for the equipment covered in this manual should be referred to the local dealer from whom the equipment was purchased, or the nearest Lewis Brothers Dealer.

We sincerely thank you for purchasing Lewis Brothers equipment.

# **TABLE OF CONTENTS**

|                                       |    |
|---------------------------------------|----|
| INTRODUCTION                          | 2  |
| SAFETY                                | 4  |
| Owner's And Operator's Responsibility | 5  |
| General Precautions                   | 6  |
| WARRANTY                              | 8  |
| Limited Warranty                      | 9  |
| SPECIFICATIONS                        | 10 |
| SETUP AND OPERATION                   | 12 |
| Machine Setup                         | 13 |
| Tractor Settings                      | 13 |
| Attachment to Tractor                 | 13 |
| Operating Instructions                | 15 |
| Spreader Installation                 | 18 |
| Turkey Operations                     | 20 |
| Setup for Total Clean out             | 21 |
| Towing and Transport                  | 22 |
| STORAGE                               | 23 |
| MAINTENANCE                           | 25 |
| Chain Adjustments                     | 26 |
| Lubrication and Hydraulic Oil         | 34 |
| Tires                                 | 34 |
| Repairs                               | 34 |
| DECALS                                | 35 |
| PARTS                                 | 38 |

# **SAFTEY**

# **OWNER'S AND OPERATOR'S RESPONSIBILITY**

This manual is intended for use with your Lewis Poultry Housekeeper. Extra effort has been made to provide for safe operation of this equipment. This manual as well as the safety decals placed on the equipment is part of that effort. Your new Housekeeper should perform the various functions for which it was designed if it is maintained, adjusted to your specific conditions, and operated correctly.

It is the responsibility of the owner and every operator of this equipment to read and understand this manual before initial startup, before each season, before performing service or maintenance tasks and prior to storing the equipment. Each employee who will work on or around this equipment should be instructed in how to do so safely.

It is important to understand the operational methods and safety issues mentioned in this manual. Lewis Brothers cannot anticipate all conceivable ways service and operational functions might be performed and of the possible hazardous consequences of such. Anyone using or servicing this equipment must first satisfy themselves that their chosen methods do not jeopardize the safety of themselves, others, or the equipment.

Read the warranty on page 9. The purchaser is required to fill out and return the registration card supplied with this owner's manual within ten (10) days of purchase to Lewis Brothers Manufacturing to be eligible for warranty coverage.

Genuine Lewis replacement parts will insure the durability and long life of your Housekeeper. Lewis repair parts and optional equipment should be ordered through your Lewis Brothers' Dealer.

Operators should thoroughly inspect the Housekeeper before and after each use. All chains and bearings should be properly lubricated as specified, and any worn or damaged parts repaired or replaced. Failure to repair or replace worn parts could result in damage or excess wear to other parts.

# GENERAL PRECAUTIONS

- **MAKE SURE** everyone is clear of the equipment before starting the tractor's engine and while equipment is under operation.
- **DO NOT** allow anyone to ride on this equipment.
- **KEEP** hands, feet, hair and clothing away from all moving parts. Do not wear loose clothing while operating equipment, as this may present an entanglement hazard.
- **DRIVE** the pulling tractor at speeds compatible with conditions and good safety practices. This is especially important when operating over rough ground, on slopes, crossing ditches or while turning. Tip over may occur if a safe speed is not maintained during operation.
- **STOP** the tractor's engine and relieve any hydraulic pressure by actuating all hydraulic valves in both directions before disconnecting any part of the hydraulic system.
- **MAKE SURE** hitch components are attached securely before operating or transporting.
- **USE** flashing warning lights when on highways, except where prohibited by law.

- **STOP** tractor engine before leaving operator's position to adjust, lubricate, clean or unclog machine.
- **KEEP** all shields in place.
-  **DANGER** Chock wheels and block up head of machine securely prior to working under machine. Failure to do so may result in serious injury or death.
- **MAXIMUM** towing speed is 25 MPH.
- **OBSERVE** all safety decals located on machine. Should any safety decal become damaged unreadable, or lost, **REPLACE IT IMMEDIATELY**. New decals may be obtained from your Lewis Brothers' dealer.
- **WEAR** dust respirator at all times while using this machine (3M part # 8710 is recommended).
- **R.O.P.S.** use ROPS and seat belts whenever and wherever applicable. If your tractor has a foldable ROPS, fold it down only when absolutely necessary and fold it up and lock it again as soon as possible. Do not wear seat belt when the ROPS is folded. We strongly recommend the use of ROPS and seat belts in almost all applications.

# **WARRANTY**



# **LEWIS BROTHERS MANUFACTURING, INC.**

## **LIMITED WARRANTY**

Lewis Brothers Manufacturing, Inc. (hereinafter referred to as "LBM") warrants each item of new equipment manufactured by LBM to be free from defects in material and workmanship under normal use and service.

The obligation of LBM under this LIMITED WARRANTY is limited to repair or replacement, as LBM may elect, of any parts that prove, in LBM's judgment, to be defective in material and workmanship within the first twelve (12) months after the date of invoice to the original purchaser. THIS LIMITED WARRANTY DOES NOT APPLY TO BELTS, HYDRAULIC HOSES, TIRES, AND OTHER SERVICE ITEMS, WHICH SHALL HAVE A NINETY (90) DAY WARRANTY.

**THIS LIMITED WARRANTY WILL APPLY FOR (3) MONTHS ONLY WHEN THE UNIT IS USED IN A COMMERCIAL APPLICATION.**

All warranty part repairs and replacements must be made by a certified LBM dealer. Any outside work or alterations made without written approval of LBM will render this LIMITED WARRANTY void.

LBM's obligation specifically excludes any liability for consequential damages, such as loss of profit, delays, expenses, damage to goods or property used in connection with or processed in or by the product sold, or damage to the product sold from whatever cause, whether or not such loss is due to negligence by LBM.

This LIMITED WARRANTY shall not apply to any item that has been operated in a manner not recommended by LBM.

No person is authorized to give any other warranties or to assume any other liability on behalf of LBM unless made in writing by Lewis Brothers Manufacturing, Inc.

THIS LIMITED WARRANTY IS IN LIEU OF AND REPLACES ALL OTHER WARRANTIES, EXPRESSED OR IMPLIED. WARRANTIES OF MERCHANTABILITY AND FITNESS FOR A PARTICULAR PURPOSE ARE EXCLUDED, AS ARE ALL OTHER REPRESENTATIONS TO THE USER-PURCHASER AND ALL OTHER OBLIGATIONS OR LIABILITIES, INCLUDING LIABILITY FOR INCIDENTAL AND CONSEQUENTIAL DAMAGES, ON THE PART OF LBM.

***LEWIS BROTHERS MANUFACTURING, INC.***  
***P.O. BOX 146 - BAXLEY, GA. 31513***  
***FEBRUARY 1, 2007***

# **SPECIFICATIONS**

# SPECIFICATIONS

## Housekeeper Model # 3.5

|                              |              |
|------------------------------|--------------|
| Overall Working Height       | 64 inches    |
| Overall Length               | 20 1/2 feet  |
| Width (outside tires)        | 79 inches    |
| Overall Width                | 83 inches    |
| Throat                       | 69 inches    |
| Capacity                     | 135 cubic ft |
| Weight (unloaded)            | 5200 lbs.    |
| PTO Hydraulic Pump           | 20 gallons   |
| Hydraulic Pressure @ 540 rpm | 2350 PSI     |
| Tire Pressure                | 50 PSI       |
| Tire Size - Single           | 12.5L x 16   |
| Tandem (optional)            | 9.5L x 15    |
| Hydraulic Oil                | AW-68        |
| Oil Reservoir Capacity       | 30 gallons   |
| Tractor Horsepower required  | 60 HP        |
| Tongue Weight (unloaded)     | 1350 lbs.    |

# **SETUP AND OPERATION**

# MACHINE SETUP

## TRACTOR SETTINGS

The Lewis Poultry Housekeeper #3.5 should be attached at the fixed drawbar for proper operation. If your tractor has an option of a 540 or 1000 rpm PTO, you should install the 540 shaft.

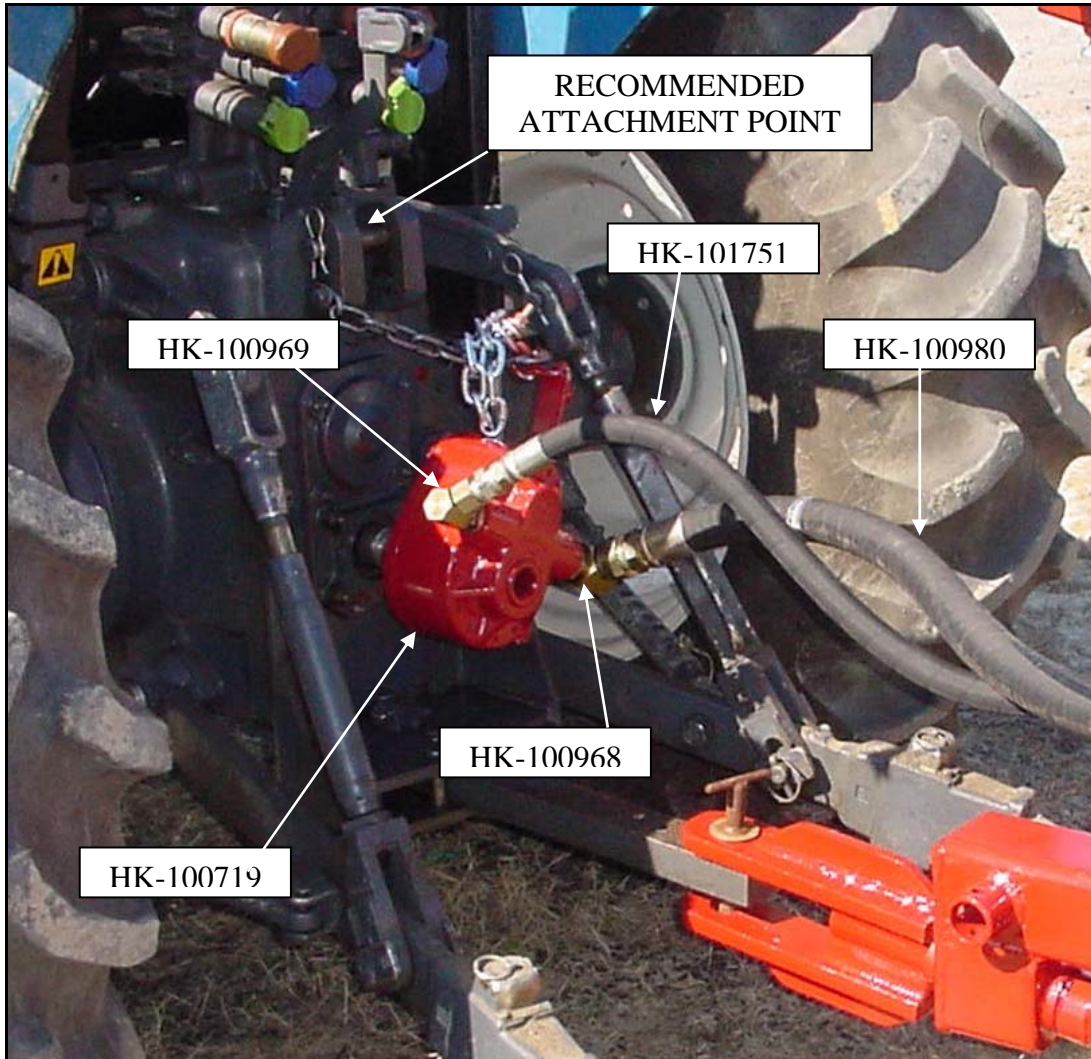

Figure 1

## ATTACHING HOUSEKEEPER TO THE TRACTOR

Attach the Poultry Housekeeper to the tractor's fixed drawbar using a heavy-duty hitch pin. Next, attach the hydraulic pump to the tractor PTO shaft. Slide the pump onto the PTO shaft as far as possible. Secure its position by wrapping the chain on the torque arm around some portion of the tractor hitch which is secure and will not allow the pump to slide off or spin once the PTO is engaged. A good place to chain the pump is around the top link pin. Always try to pull the pump from the

PTO after it is chained into place. If the pump slides very far back on the shaft it is not snug enough. Take up another link on the chain and repeat the process again. Making this connection too tight may put excess pressure on the PTO shaft resulting in damage to pump or shaft. (See figure 1)

The tongue of the unit can be moved to the far right position so that the pickup head will be positioned closer to the poultry house wall. Before starting to clean out a house, the operator should decide whether to start next to the walls or in the middle of the house and set the tongue accordingly. Always set the tongue back to the center position when not cleaning next to the walls or a row of posts, and before leaving the house. (See Figure 2)

The main control valve should be adjusted so that it is easily accessible to the operator, but not so close that it will make contact with the tractor.

**CAUTION** The Oil Supply Valve Handle must be in the horizontal position at all times during operation in order to supply full flow to the system. Be sure to check before engaging the pump. Failure to maintain this position will damage the pump.

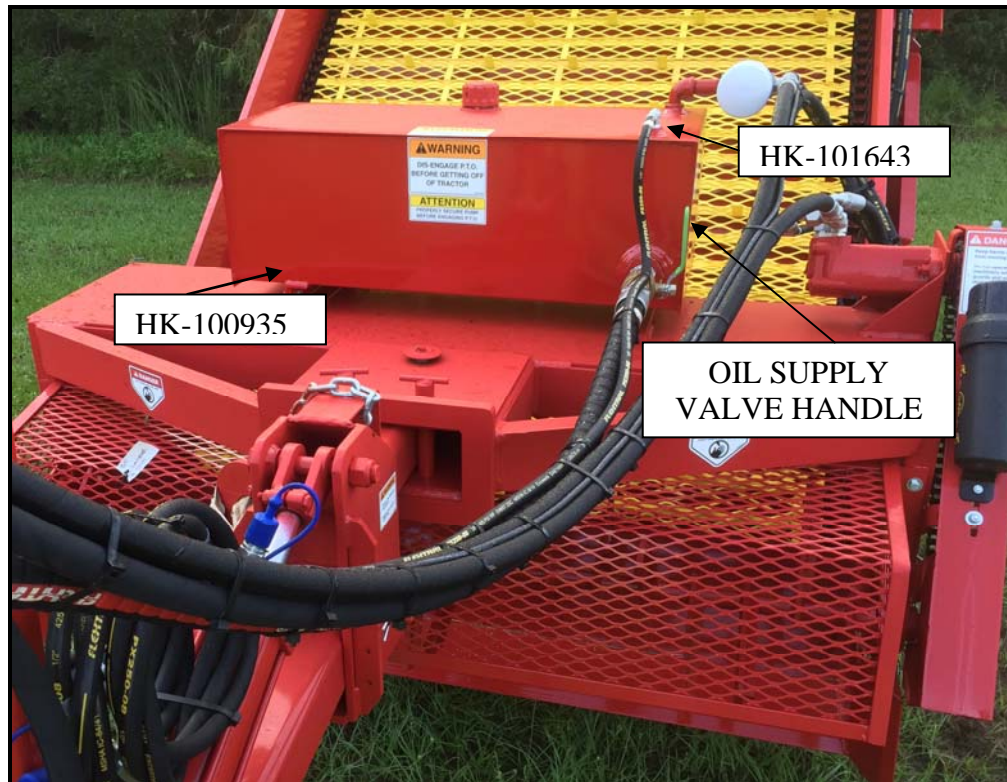

Figure 2

## **OPERATING INSTRUCTIONS**

The Lewis Poultry Housekeeper is designed to be operated with the tractor PTO turning within a range of 500 to 540 RPM. 540 RPM is the most desirable speed and will produce the maximum flow and pressure from the pump. It is important to allow the hydraulic oil adequate time to reach operating temperature. This should take around 15 minutes and oil temperature should be near 80 degrees. Failure to warm up the oil will cause cavitations and damage the internal components of the pump. To put the machine into operation, first engage the PTO of the tractor and then pull the control valve handle forward. This should start the cylinder reel, loading conveyor and the leveling assembly into motion. Next, bring the PTO of the tractor up to speed.

The ground speed will depend on the particular operation being performed and the amount of material being removed from the floor of the house. Generally, first gear or 1 to 1-1/2 MPH is used for total clean out and removal of medium cake during sifting. Very heavy cake or excessive ground speed may cause litter to be pushed in front of the machine. The Poultry Housekeeper operates best at a depth of 3-4 inches. If litter or cake is deeper than four inches it is recommended that two passes be made through the house to clean or sift the litter. In excessive cake the ground speed may be reduced to help sift the total cake in a single pass. Higher gears may be used when sifting where the litter does not exceed 3-4 inches and where cake is light.

Speeds of the drive components are very important to the performance of the Poultry Housekeeper. PTO speeds in the 500-540 ranges should be maintained at all times during operation.

The ability to shake the loading conveyor while sifting the litter is what makes the Lewis Poultry Housekeeper work so well. Shaking makes the separation process work by allowing the smaller particles to pass through the screens while the larger “cakes” are tumbled for a short time before being carried into the body. The gentle lifting and shaking process keeps wet litter and feathers from passing through the screens.

Setting and maintaining the proper blade depth is important for maximum performance. To properly set the depth, slowly lower the front of the Poultry Housekeeper into the litter with your tractor.

Lift until the desired depth is reached. It may take some time to become accustomed to how deep the blade is running. By observing the blade and loading cylinder during operation, proper depth can be determined for the given conditions.

In houses where uniform amounts of material will be removed, set the stops on the tractor lift. This will provide consistent blade depth each time the machined is raised or lowered.

The body loads from front to rear, and although it is sometimes difficult to see the rear of the machine because of the dust, the operator will know the body is full when the leveling bars begin to kick litter into the air. When this occurs, move the control valve handle to the center position to disengage the conveyor. The load is now ready to be transported and unloaded at the desired site.

The body may be unloaded by spreading or by a quick dump method. If the spreading method is to be used, refer to the section on "Spreader Installation and Operation" on the following pages. To do a quick dump as in composting or stockpiling:

1. Make sure the bumper and spreader are not attached and that the hydraulic hoses are connected properly. Remove tailgate lock-down bolts and the tension springs from upper section of the tailgate. Store these in a secure place for later installation.
2. The center springs and pins should be installed between the upper and lower sections of the tailgate as shown in (figure 3). This will cause the tailgate to become rigid and function as one piece while litter is being transferred rearward. Failure to install these properly will result in improper unloading of litter.
3. Once you have reached the composting or unloading site, push the control valve lever to the rear and begin the unloading process. The unloading chain will drag the litter out the back of the machine. Forward movement of the machine may be necessary to allow for litter being discharged.
4. After all the litter has been discharged, pull away from the pile and move the control lever forward to the loading position This will engage the tailgate cylinder and cause the tailgate to return to the closed position. It is important to unload all the litter or the tailgate will not close properly. The machine is now ready to be re-loaded.



**⚠ CAUTION**

Never back the Lewis Poultry Housekeeper while the loading assembly is in the down position and in operation! Litter and other objects may be forced into the rear of the loading assembly and possibly cause the assembly to jam. Always lift the front of the machine or stop the assembly before backing the machine.



Figure 3

# **SPREADER INSTALLATION AND OPERATION**

## **INSTALLATION**

1. The spreader unit comes pre-assembled and is attached to the main frame of the Housekeeper using four 1/2x1-1/2 inch bolts.(see figure 4)
2. Locate the hydraulic 'quick-coupler' attached to the base end of the tailgate cylinder and uncouple the fittings from the coupling block (see fig. 5). Connect the two ends to the matching fittings on the hydraulic motor located on the spreader assembly.
3. Install the bumper and the diverter assembly.
4. Remove the pins and springs in the center section of the tailgate and store in a secure location.
5. Attach the lower tailgate tension springs from the tailgate to the frame

## **OPERATION**

Two primary concerns when spreading litter are the amount being applied and the pattern of distribution. The settings for the discharge rate will vary depending on the consistency of the litter. The common setting for dry litter is position No. 5 on the control valve. The flow control valve may be increased or decreased depending on the volume of litter to be applied.

The distribution pattern is influenced by the location of the diverter attached to the rear bumper. Best results are achieved when the diverter is positioned at approximately 45 degrees. (See Figure 6)

Fresh litter may be spread in the house with the Housekeeper once the clean out process has been completed. Shavings may be loaded into the body of the Housekeeper with a front loading device or by picking up the shavings with the loading conveyor of the Housekeeper itself. If equipped with perforated bars, you will need to remove the shaker wheels and operate the Housekeeper in the slowest gear and speed.

The unloading and spreading process requires a lot of hydraulic capacity both in volume and pressure. It is not uncommon for low horsepower tractors to become heavily loaded during these operations. Slower speeds may be required if this situation occurs.

**⚠ WARNING** Do not operate the spreader with anyone standing behind the machine. The material being discharged is traveling at a high rate of speed and could contain objects capable of causing serious personal injury.



Figure 4

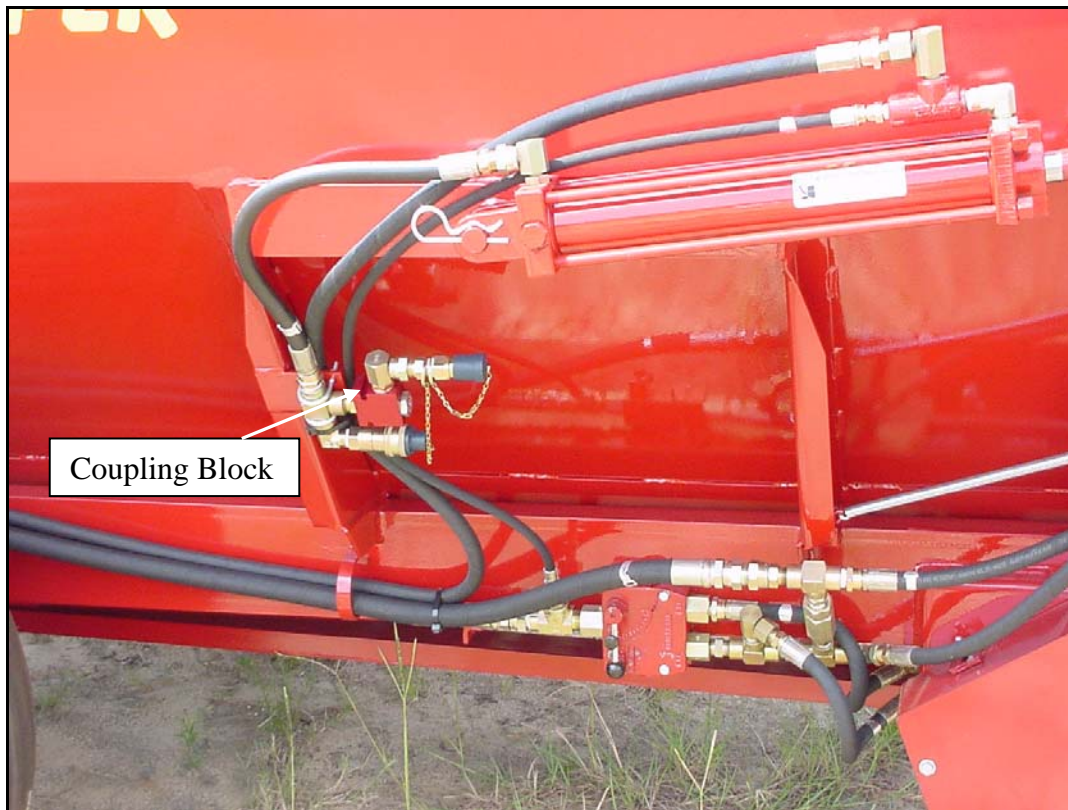

Figure 5

## **TURKEY OPERATIONS**

When the Lewis Poultry Housekeeper is used in very heavy turkey cake, it may become necessary to slow the ground speed to 1/2 MPH. This works best because it is very difficult to cut through turkey litter due to the very large feathers present. Additionally, feathers may wrap around the blade and loading cylinder, causing litter to be pushed ahead of the machine. The following procedure must be followed to properly remove the feathers from the loading blade.

1. Stop the tractor.
2. Disengage control valve.
3. Back the tractor up with the head in the down position.
4. Stop the tractor.
5. Engage control valve to loading position.
6. Start tractor in a forward motion again.
7. All feathers are wiped from the loading blade and are then loaded into the body.

The wide head enables the Housekeeper to start from the walls and work towards the center of the house. There is little need to overlap since the head is as wide as the tire track. The floor is left smooth and ridge free.



Figure 6

## **SETTING THE MACHINE FOR TOTAL CLEANOUT**

Setting the machine for total clean out requires that all perforated bars utilized for caking or sifting be removed and replaced with solid bars. The best method to achieve this is to first remove all perforated bars before installation of the solid bars. The use of an impact wrench will make this job easier and much faster. Once all perforated bars have been removed, the shaker wheels (See figure 8) must then be removed. This must be done prior to the installation of the solid bars. Replace the solid bars one at a time using the same hardware. Replace the bars on the front of the machine then rotate the conveyor chain over and replace the remaining bars.

## **TOWING AND TRANSPORTING**

A tractor of sufficient weight and power is required to both pull and control a Lewis Brothers Housekeeper over the terrain in the given area of operation. A tractor with a minimum of 60 PTO hp is required for proper operation of the # 3.5 Housekeeper. In order to have full control, your tractor must be able to maintain traction under all turf or surface conditions. Additional weights may be required to the front of the tractor to avoid unstable towing conditions.

If it becomes necessary to tow the Poultry Housekeeper behind a truck for extended distances the following is recommended. Secure the hydraulic pump with the torque bar chain on the tongue. (See figure 6A) Tie up all hoses to prevent them from dragging or becoming damaged. Tongue weight for towing is approximately 1300 to 1500 lbs. The truck used for towing must be heavy enough to pull the Housekeeper, but more importantly must be equipped to safely stop under the additional load.

The hitch height must provide a clearance of five to six inches below the blade of the Housekeeper after the Housekeeper has been attached to the towing vehicle. Maximum caution should be maintained at all times when transporting the Lewis Housekeeper.



Figure 6A

# STORAGE

## **STORAGE**

After each use, the Poultry Housekeeper should be washed down thoroughly removing all litter, inside and out. After washing, treating with a disinfectant is recommended in order to kill any remaining bacteria. The next step is treating the machine with soluble oil to protect it from rust and corrosion. One product that meets these requirements is called LPS#3. You may find this or other similar products at your Lewis Poultry Housekeeper Dealer, tractor dealerships, or farm supply stores. It is important to remember that all chains must be properly lubricated before and after each use and especially before storage.



When washing the Housekeeper, never allow a high-pressure water stream to come in contact with bearings or idler seals. Water can be forced into the bearing and will cause premature failure.

Check all safety decals and make any necessary replacements. Decals may be obtained from your Lewis Dealer.



# **MAINTENANCE**

# MAINTENANCE

## CHAIN ADJUSTMENTS

Periodical adjustments may be necessary to the conveyor chains, drive chains and leveling assembly chains.

With the operator in front of the Housekeeper and facing towards the machine, the **loading cylinder drive chain** will be located on the right side of the machine. As it wears and stretches from use, the idler sprocket should be adjusted to remove any slack.

Proper tension on the chain should allow for approximately 1 inch of movement in the tightness of chain. (See figure 7)



Figure 7

The **loading conveyor chain** will also need adjusting as it wears. To adjust the tension on the chain, loosen all bolts on the base of the upper loading shaft bearing. Next, tighten the adjustment nut on the adjustment rod located at the top of the assembly. Be sure to adjust both sides of the assembly equally before securing the bolts. (See figure 8)

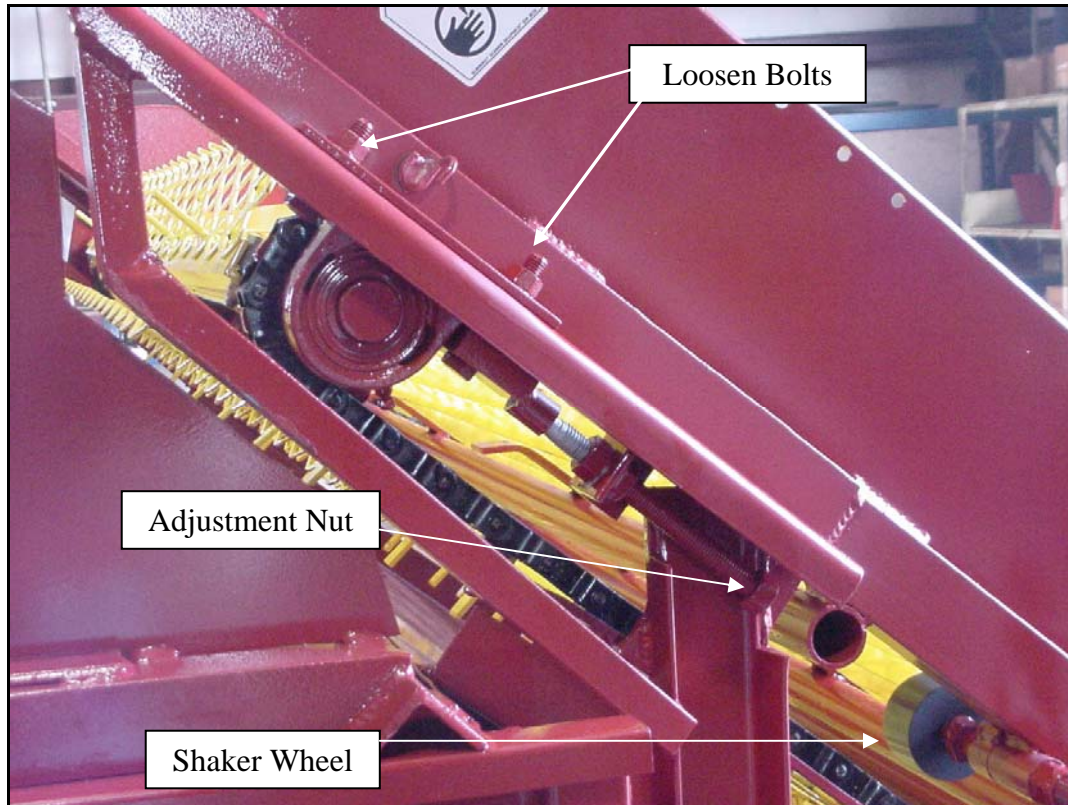

Figure 8

Proper tensioning of this chain should allow you to lift the chain off the side runners between 1-1/2 to 2 inches. (See Figure 8a) When the chain stretches far enough that it cannot be tightened, you must remove two links and one bar and reconnect the chain. Do this by grinding out selected link pins. Reassemble the chain by using an attaching link. Be sure to remove and replace any damaged bars or worn chain links. When adjusting the tension on the leveling chain, there should be contact between the chain and the lower runner with the chain slightly rising off the lower runner at the rear of the machine. (See Figure 8b)

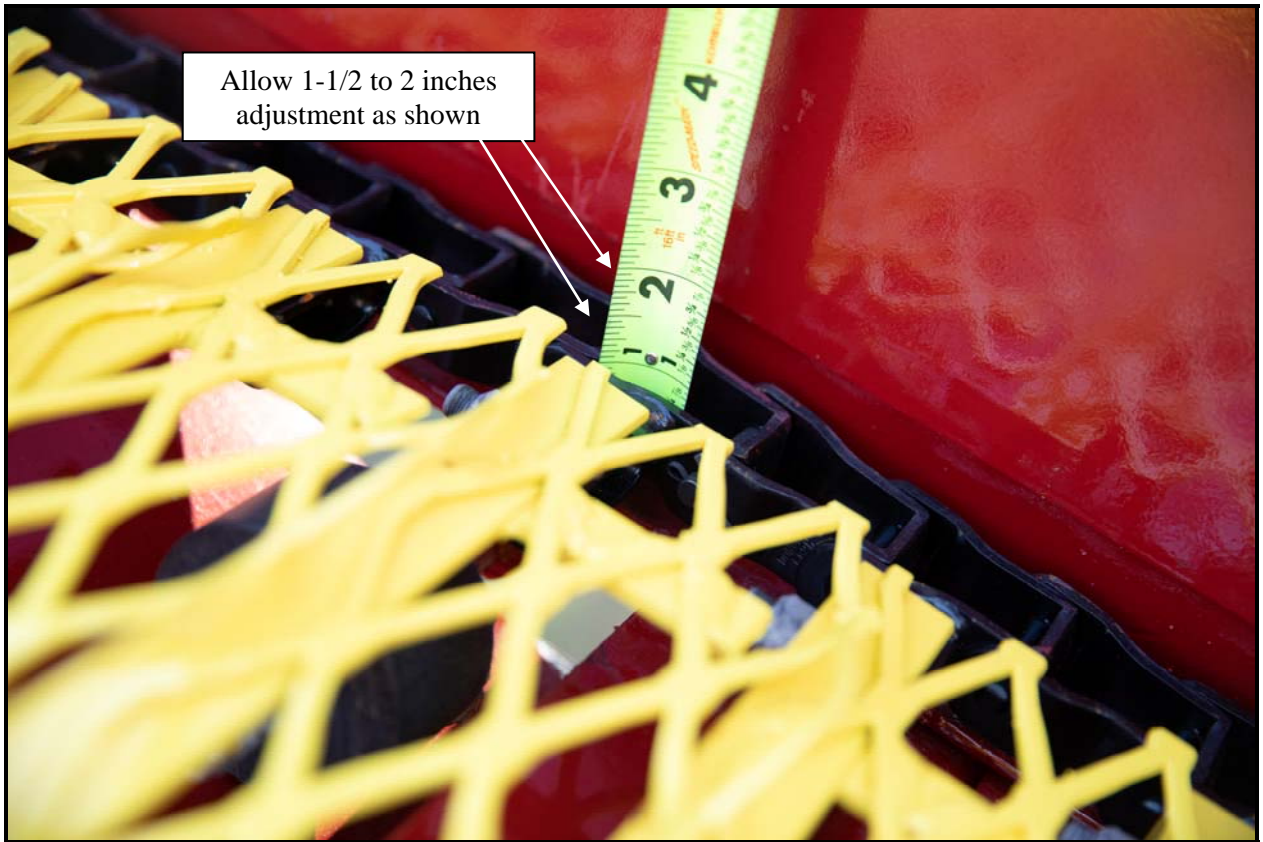

Figure 8a

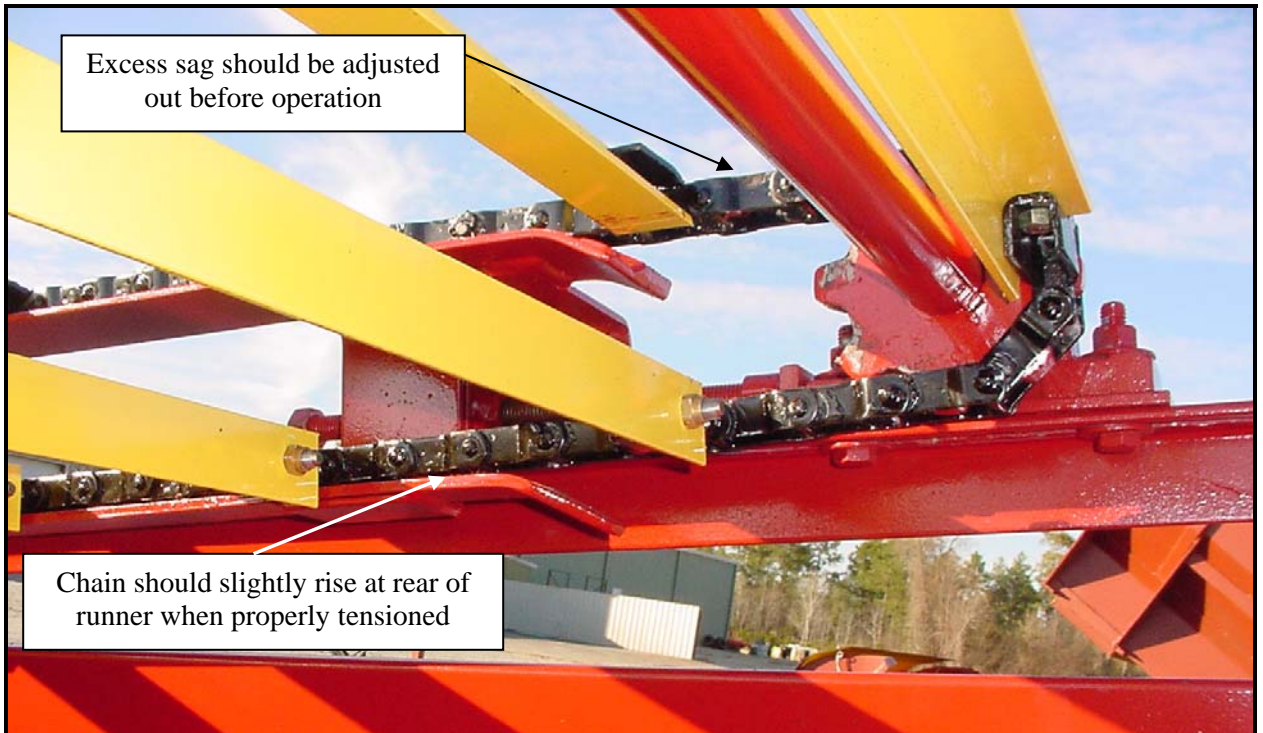

Figure 8b

The **leveling chain assembly** is adjusted from the rear of the assembly. Begin by loosening the jam nut located on the adjustment rod. Next, loosen the bearing flange bolts and turn the adjustment rod to achieve the proper tension. Special care should be taken to adjust both sides of the assembly in equal amounts. Adjusting one side more than the other will cause misalignment of the assembly and damage the assembly. (See Figure 9)

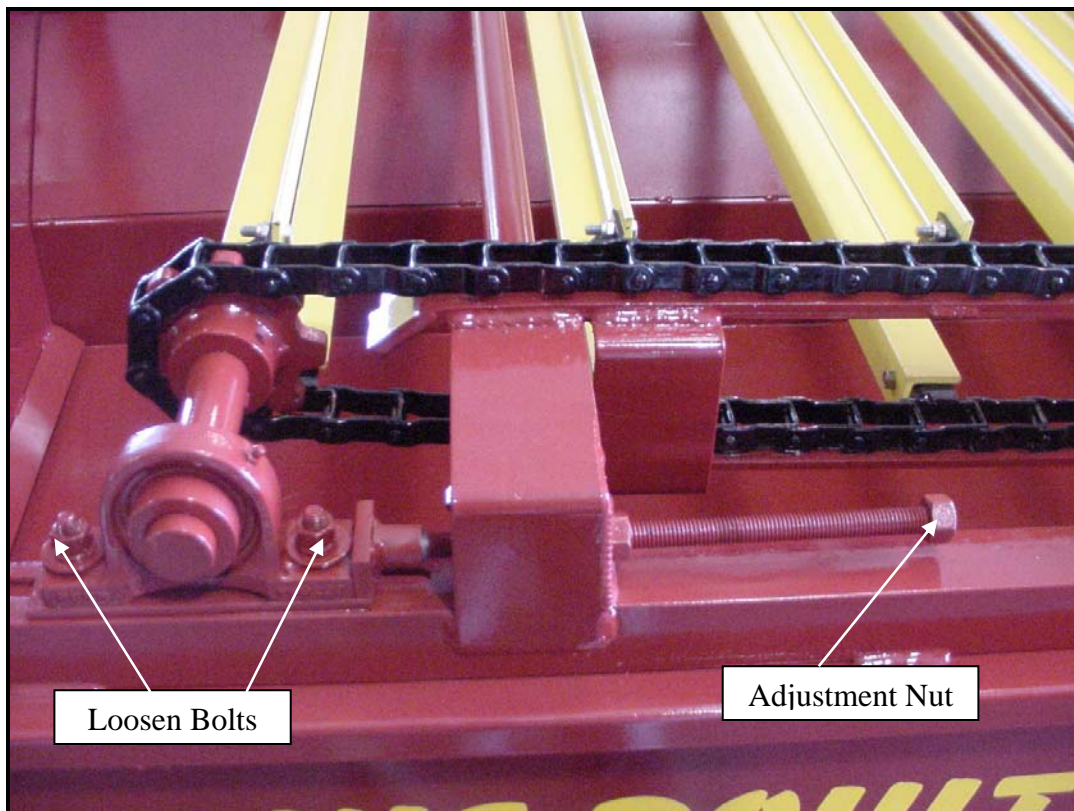

Figure 9

The unloading chain adjustment is located at the front of the chain directly behind the lower portion of the loading conveyor. Adjust both sides of the idler shaft assembly equally by tightening the adjustment nut. (See fig. 10)

The chain should be tightened until approximately 5-3/4" clearance exists between it and the body floor in order to achieve proper tensioning. This should place the bottom of the chain even with, or just below the main frame channel.

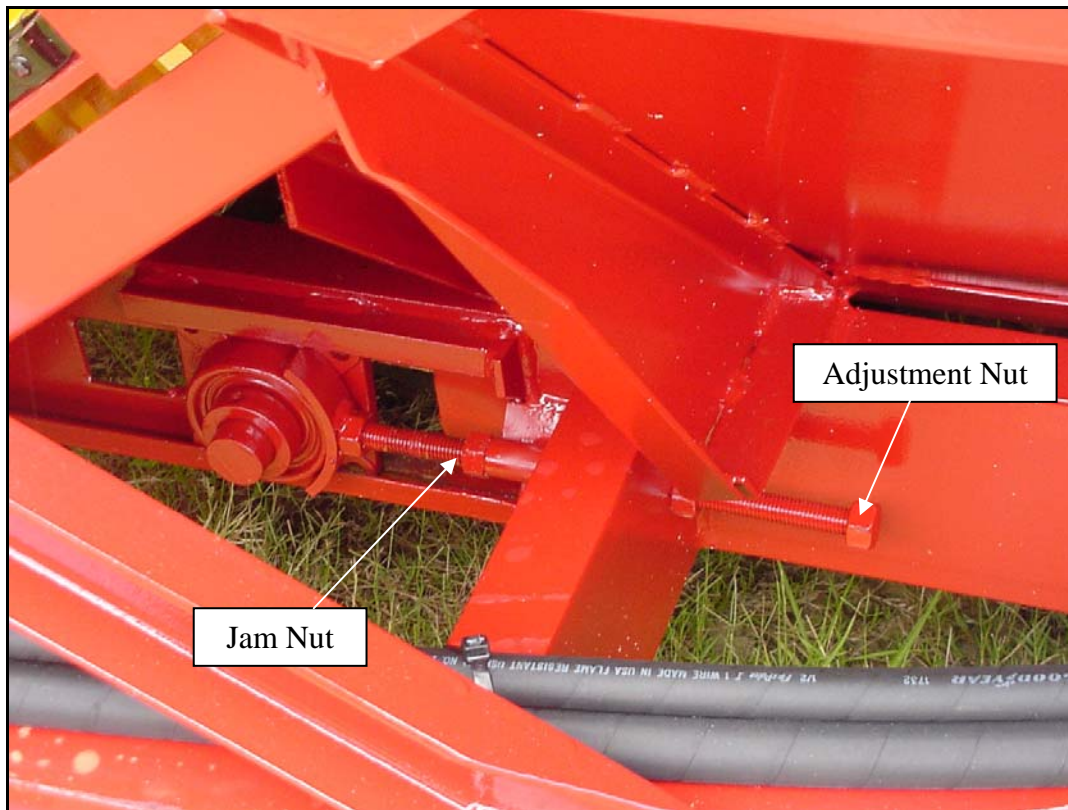

Figure 10

The unloading drive chain can be adjusted by loosening the idler and sliding it downward in the slot. (See Figure 11) Proper adjustment should allow for 1/2" to 1" of movement on the tension side of the chain when not under a load. Once the correct tension has been set, secure the idler by tightening the idler bolt and re-install the guard.

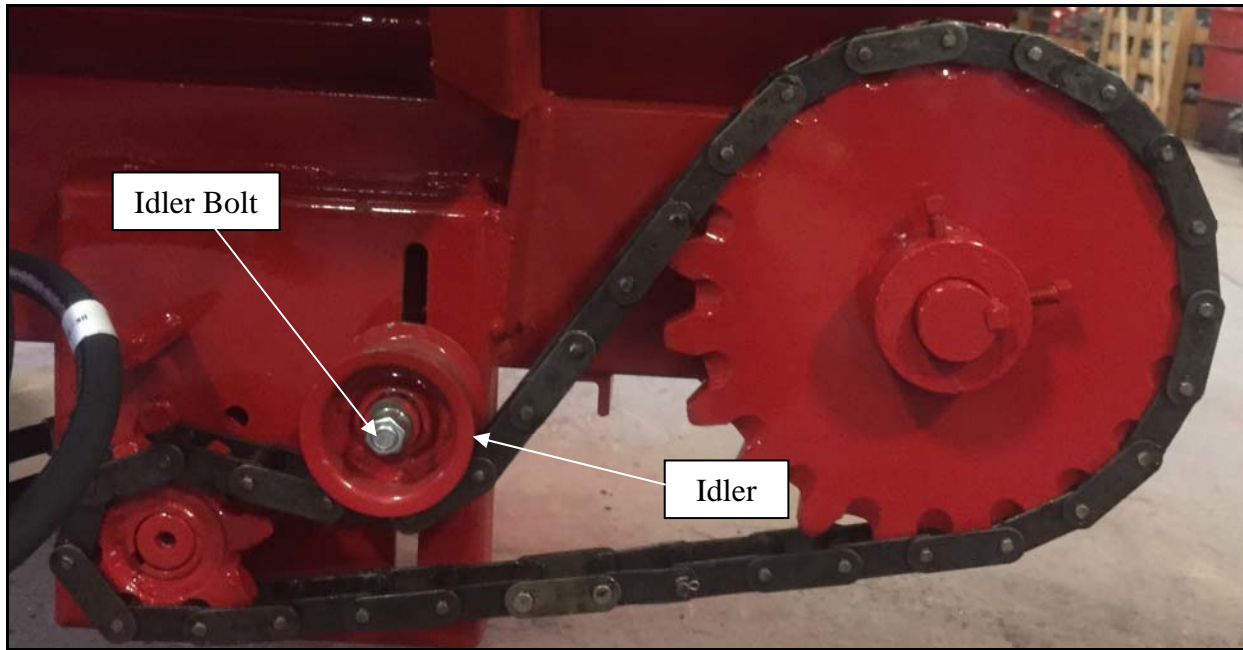

Figure 11

The drive belts on the spreader assembly may need to be adjusted over time. The first step after removing the protective guard is to loosen the idler axle bolt. Tighten the adjustment nut on the draw bolt until the proper tension is achieved. Re-secure the idler assembly by tightening the idler axle bolt. (See Figure 12)

It should take 4-5 pounds of force to deflect a single belt  $\frac{5}{16}$  of an inch at the midpoint of the longest span. If no gauge is available to make this measurement, an alternative method of measurement would be to apply moderate force using one finger to push the belt  $\frac{5}{16}$  of an inch. Once the proper tension has been achieved for each of the belts, secure their position by tightening the jam nut and axle bolt.

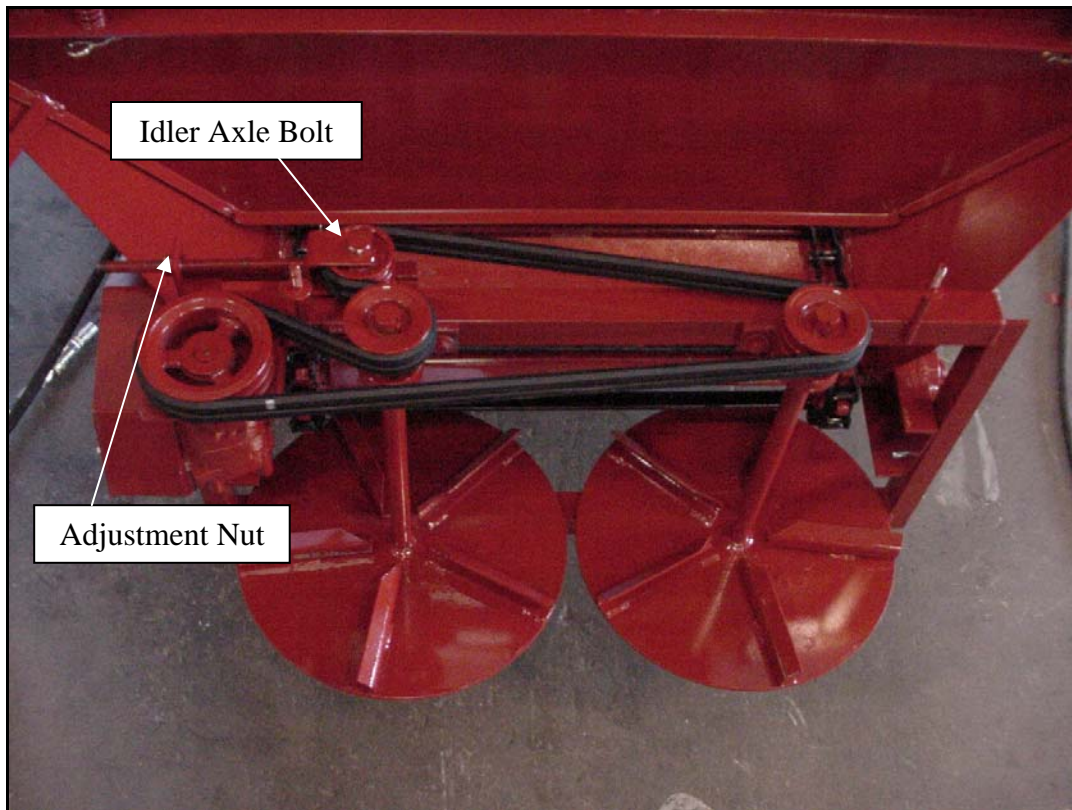

Figure 12

The loading conveyor drive chain should be checked often and any loose slack should be adjusted out before operation. This can be done by first removing the protective guard and loosening the three bolts that secure the hydraulic motor and shaft assembly. (See figure 13) Once the bolts have been loosened, slide the Motor Mount Assembly down-ward to set the proper tension on the Drive Chain, and then lower Chain Idler against the Drive chain. Be careful not to over-tighten the chain as excess tension may cause damage to the loading motor assembly.

After prolonged use, it may be necessary to remove a half link in order to take up slack due to stretching or wear. Follow the same steps as mentioned above once the half link has been removed.



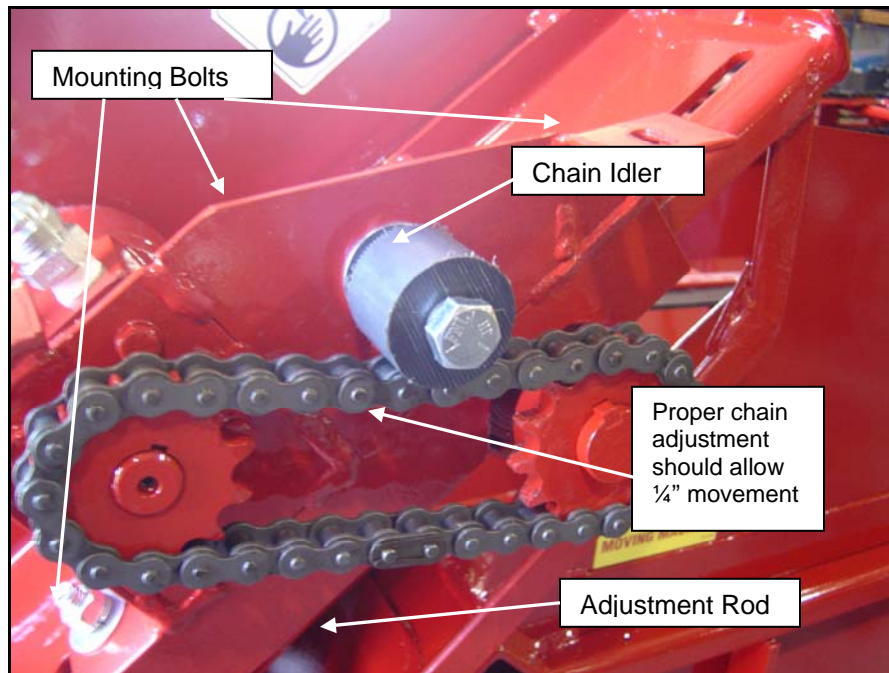

Figure 13

The leveling assembly drive chain should also be checked regularly and adjusted as needed. After removing the guard, locate and loosen the leveling shaft assembly bolts. (See figure 14) Use the adjustment rod to set the proper tension on the drive chain taking care not to over-tighten. Once the proper adjustment has been made re-tighten the assembly bolts and re-install the guard.

**ATTENTION:** Be sure to keep all drive chains well lubricated and free of any obstructions to insure proper operation.

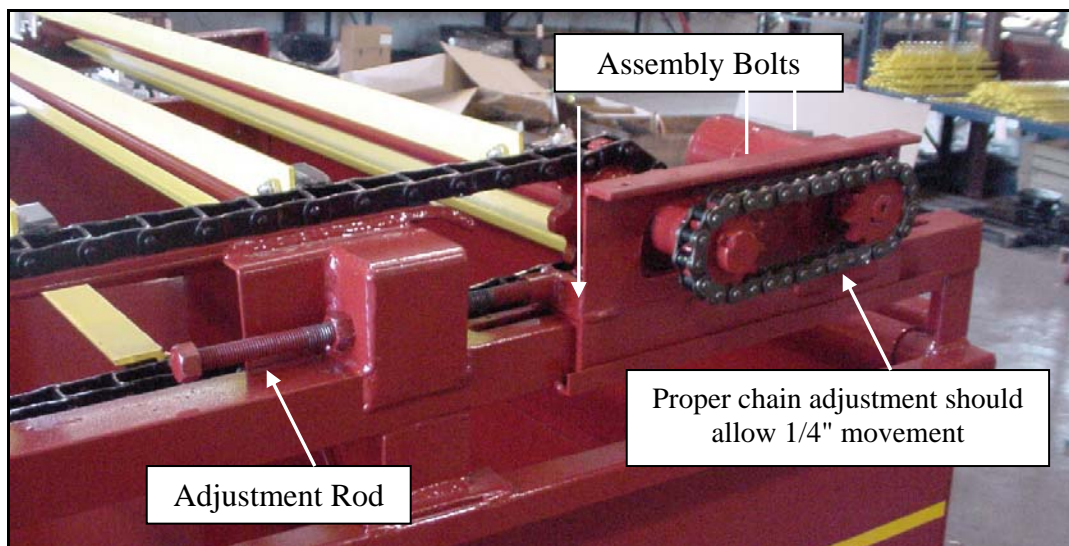

Figure 14

# **LUBRICATION**

## **HYDRAULIC FLUID**

The hydraulic fluid is a vital component of the system. Low levels may cause overheating and damage to hydraulic components. The hydraulic system holds approximately 30 gallons. With the machine on level ground, the oil level in the tank should come to within four inches of the top of the tank. If it becomes necessary to add hydraulic fluid, use petroleum based anti-wear hydraulic oil with ISO 68 viscosity grade AW 68. Oil temperature should not exceed 180 degrees Fahrenheit. In the event that components may need replacing, the hydraulic oil should also be replaced.



Always look for hydraulic leaks with the tractor's engine off. Wear hand and eye protection. Use cardboard or wood instead of your hands to search for a leak's source.

Grease all chains and bearings after each use. Change the oil filter every six (6) to twelve (12) months depending on usage.

## **TIRES**

Check tire pressure on a regular basis. Adjust the pressure not to exceed 50 PSI.

## **REPAIRS**

Check for worn or damaged components. Order needed parts from your Lewis Dealer. Make all repairs as early as possible to avoid additional expense. Prolonged use of worn or damaged parts may result in premature failure of other components.

# DECALS



HK-100903



HK-100913



HK-100923



HK-100986



HK-100908



HK-100906



HK-100916



HK-100899



**HK-100918**



**HK-100917**



**HK-100910**

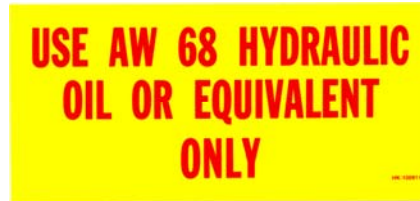

**HK-100911**

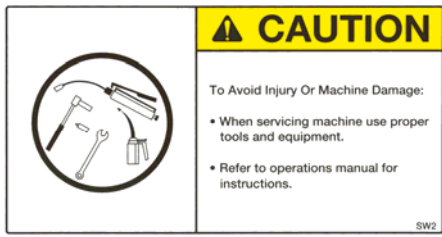

**HK-100907**



**HK-100912**



**HK-100919**

# PARTS

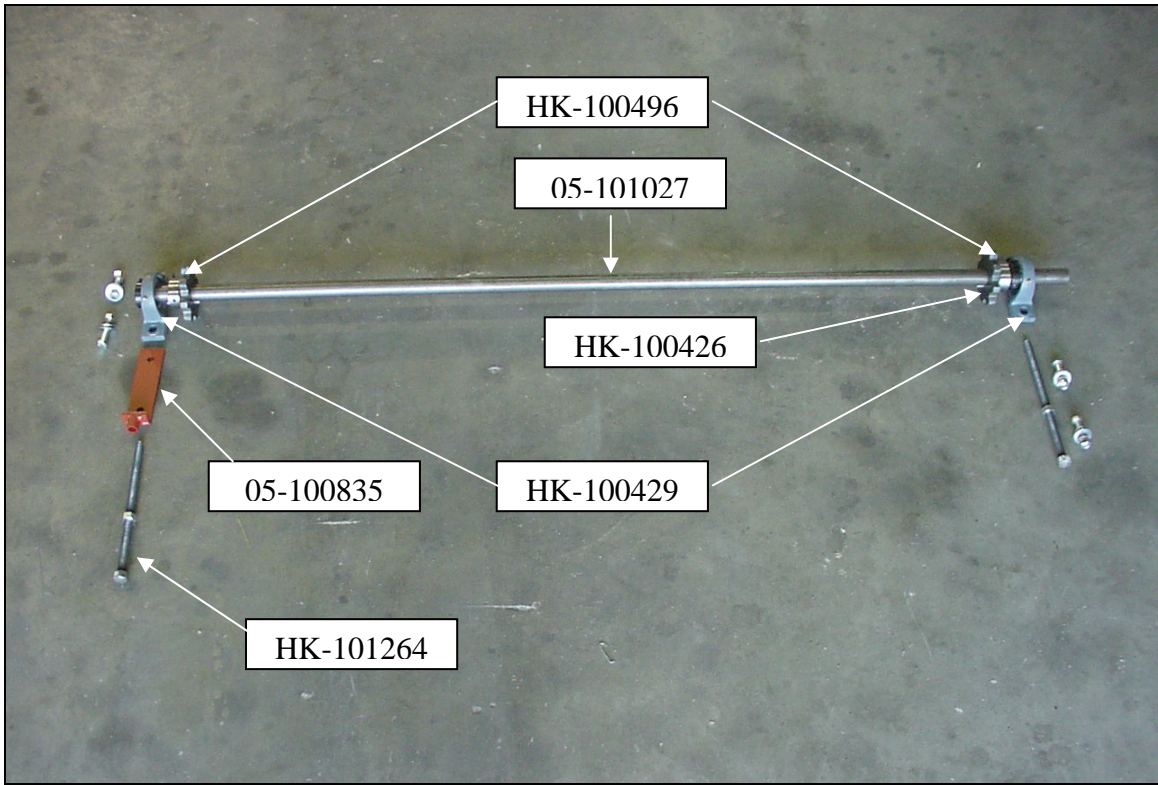

**Leveling Shaft Assembly (HK-100477)**

|           |                          |
|-----------|--------------------------|
| 05-101027 | Shaft                    |
| HK-100426 | Sprocket                 |
| HK-100429 | Bearing                  |
| HK-100496 | Key 5/16 Square X 2-1/2" |
| 05-100835 | Adjustment Rod Assembly  |
| HK-101264 | Tensioning Rod Assembly  |

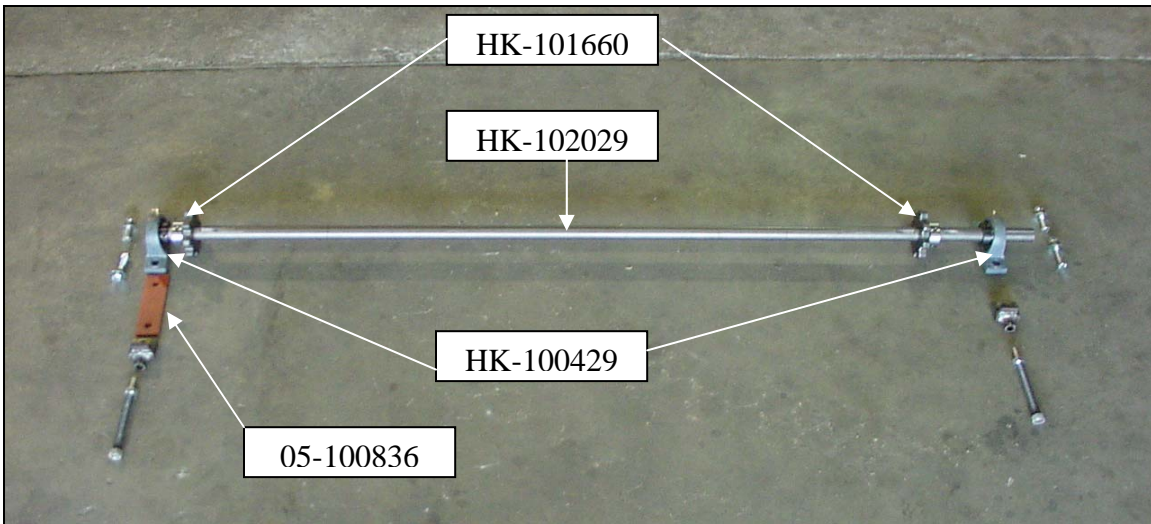

**Upper Loading Conveyor Shaft Assembly (05-100830)**

|           |   |
|-----------|---|
| HK-102029 | Shaft, Top Loading  |
| HK-101660 | Sprocket, Top Loading w/ Angular Ring (after serial # 5468) |
| HK-100429 | Bearing   |
| HK-100496 | Key, 5/16 Square X 2-1/2"                                   |
| 05-100836 | Slide, Leveling Conveyor                                    |

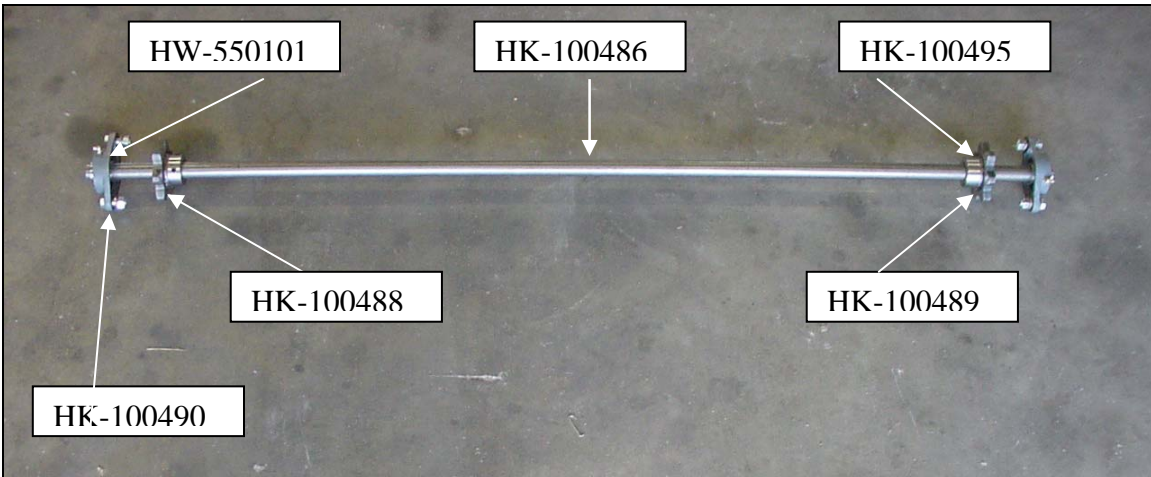

**Lower Loading Conveyor Shaft Assembly (05-101025)**

|           |  |
|-----------|--|
| HK-100486 | Shaft, Lower Loading (after serial # 5468) |
| HK-100488 | Sprocket, Lower Loading with Bushing       |
| HK-100489 | Sprocket with Keyway                       |
| HK-100490 | Bearing                                    |
| HK-100495 | Key, Cylinder Reel, 1/4 Square             |
| HW-550101 | 1/8 NPT Straight Grease Fitting            |



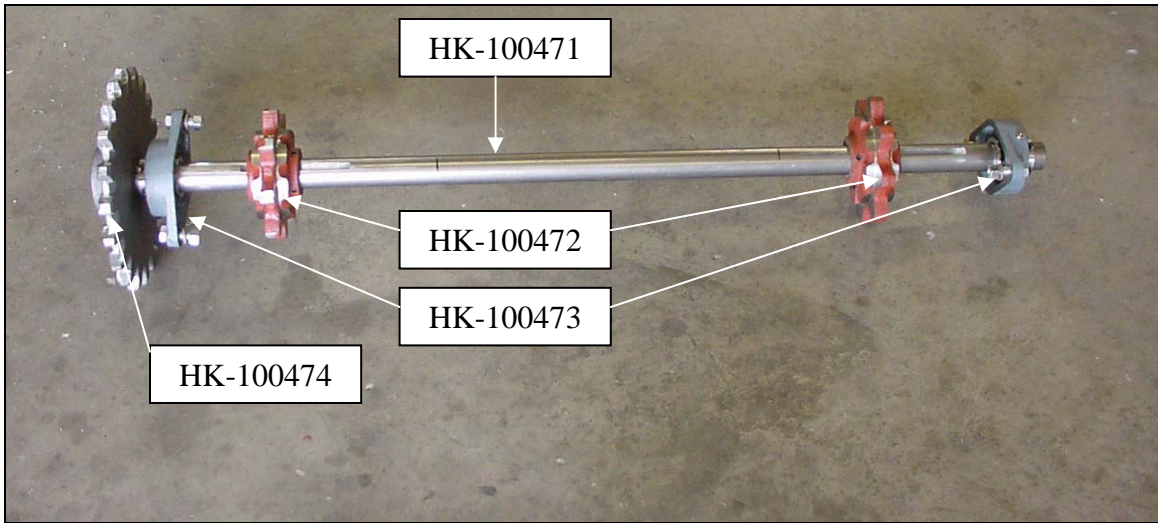

**Rear Unloading Shaft Assembly (HK-100470)**

|           |                        |
|-----------|------------------------|
| HK-100471 | Shaft, Rear Unloading  |
| HK-100472 | Sprocket               |
| HK-100473 | Bearing                |
| HK-100474 | Sprocket (see page 44) |

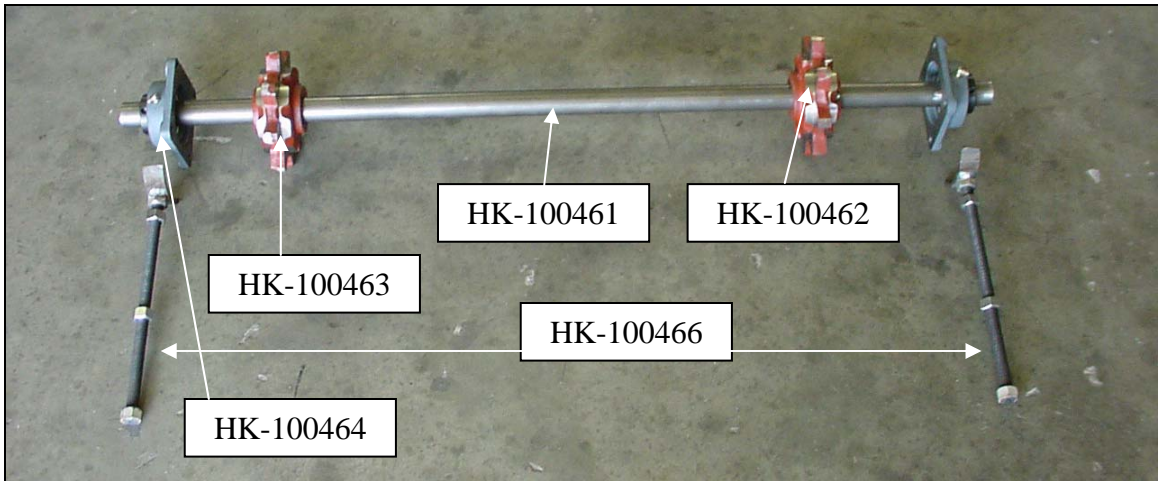

**Front Unloading Shaft Assembly (HK-100460)**

|           |                              |
|-----------|------------------------------|
| HK-100461 | Shaft, Front Unloading       |
| HK-100462 | Sprocket With Grease Fitting |
| HK-100463 | Sprocket With Set Screw      |
| HK-100464 | Bearing, Flange              |
| HK-100466 | Tensioning Rod Assembly      |

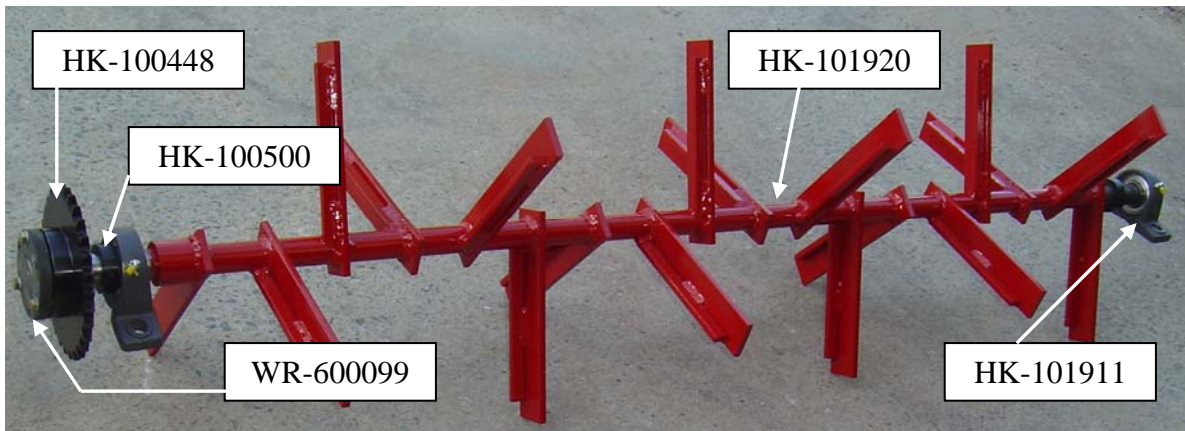

**Cylinder Reel Assembly (HK-101910)**

|           |                         |
|-----------|-------------------------|
| HK-101911 | Bearing                 |
| HK-100448 | Sprocket                |
| WR-600099 | Bushing                 |
| HK-100500 | Key 3/8 Square X 2-1/2" |
| HK-101920 | Cylinder                |

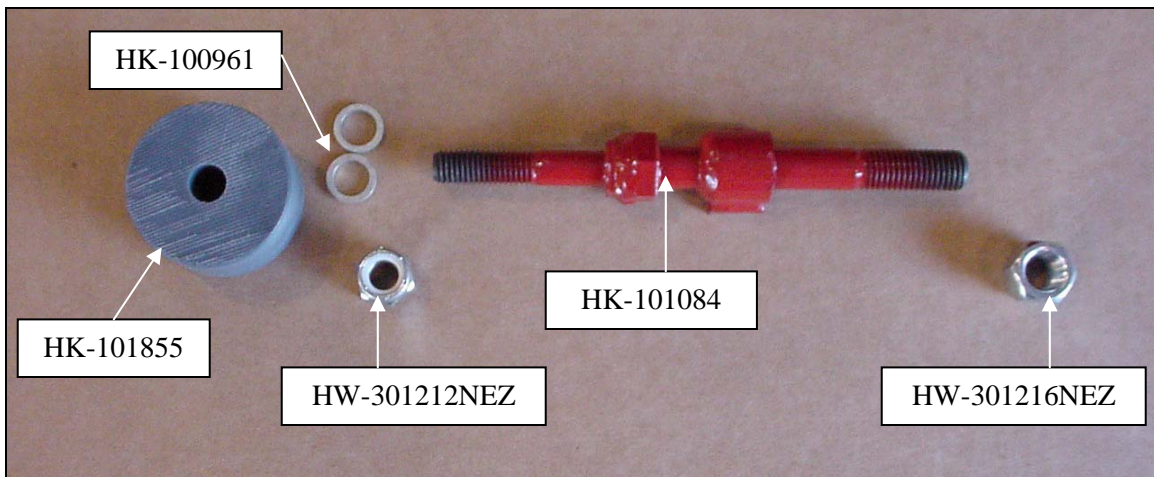

**Shaker Wheel Assembly (HK-101549)**

|              |                                 |
|--------------|---------------------------------|
| HK-100961    | Shim-Space                      |
| HW-301212NEZ | Locknut, Hex 5/8-11NC, ZP Nylon |
| HW-301216NEZ | Locknut, Hex 3/4-10NC, ZP       |
| HK-101855    | Black Shaker Wheel, Nylon       |
| HK-101084    | Shaft Assy, Shaker Wheel        |

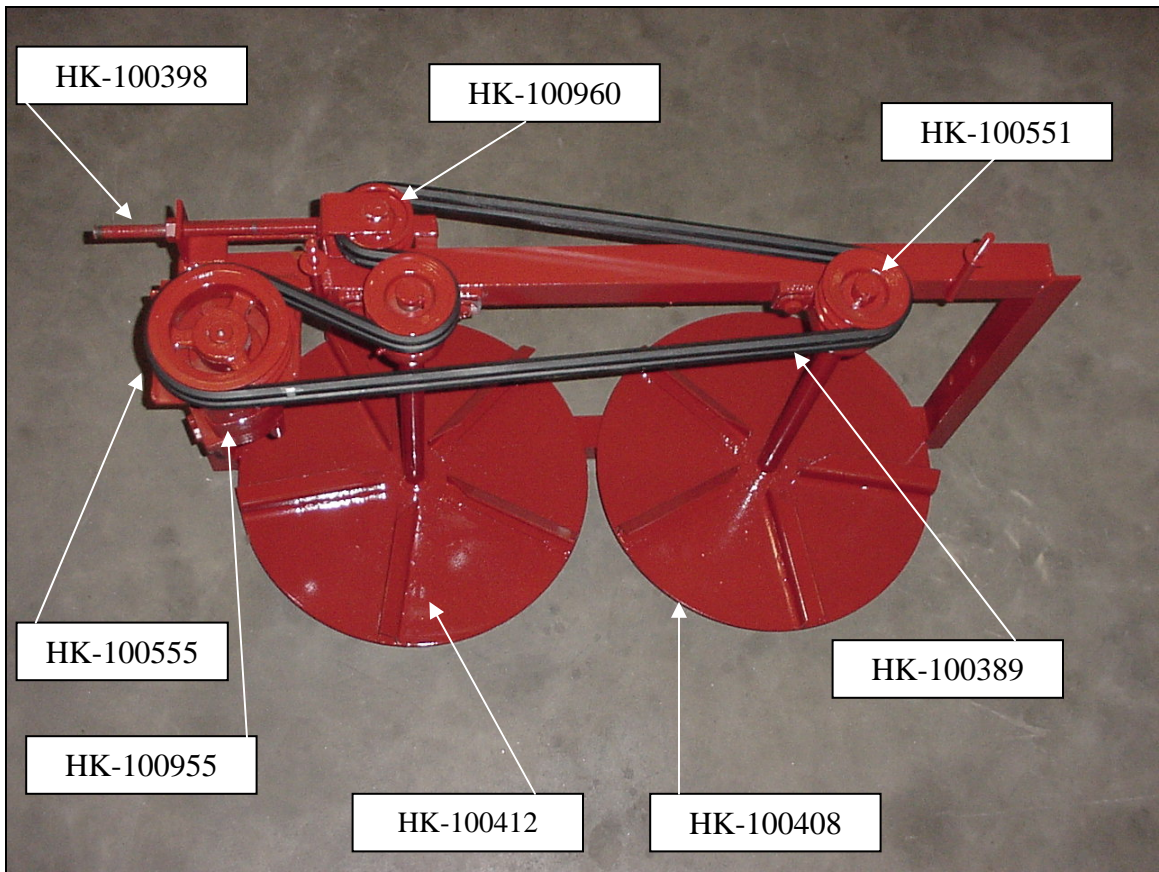

**Spinner Option**

|           |                                |
|-----------|--------------------------------|
| HK-100408 | Shaft with Blade Weldment, RH  |
| HK-100412 | Shaft with Blade Weldment , LH |
| HK-100389 | Bearing                        |
| HK-100551 | Pulley                         |
| HK-100960 | Pulley, Spreader Idler         |
| HK-100398 | Belt Adjustment Rod            |
| HK-100555 | Pulley, Leveling               |
| HK-100955 | Spinner Motor                  |
| HK-100950 | Belt                           |

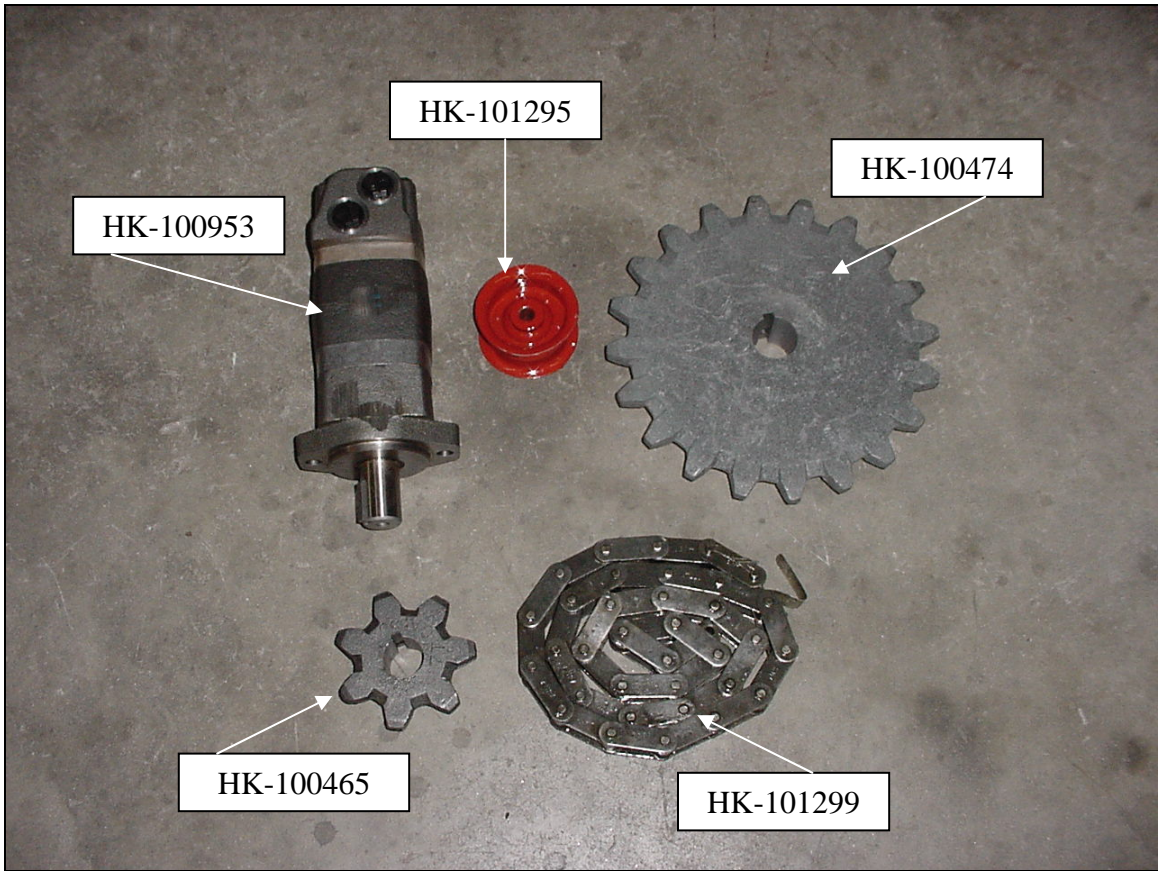

**Unloading Motor & Parts**

|           |                            |
|-----------|----------------------------|
| HK-100953 | Unloading Motor            |
| HK-101295 | Idler                      |
| HK-100474 | Sprocket                   |
| HK-101299 | Drive Chain                |
| HK-100465 | Sprocket, Unloading Drive  |
| HK-101297 | Connector Link (not shown) |
| HK-101658 | Offset Link (not shown)    |

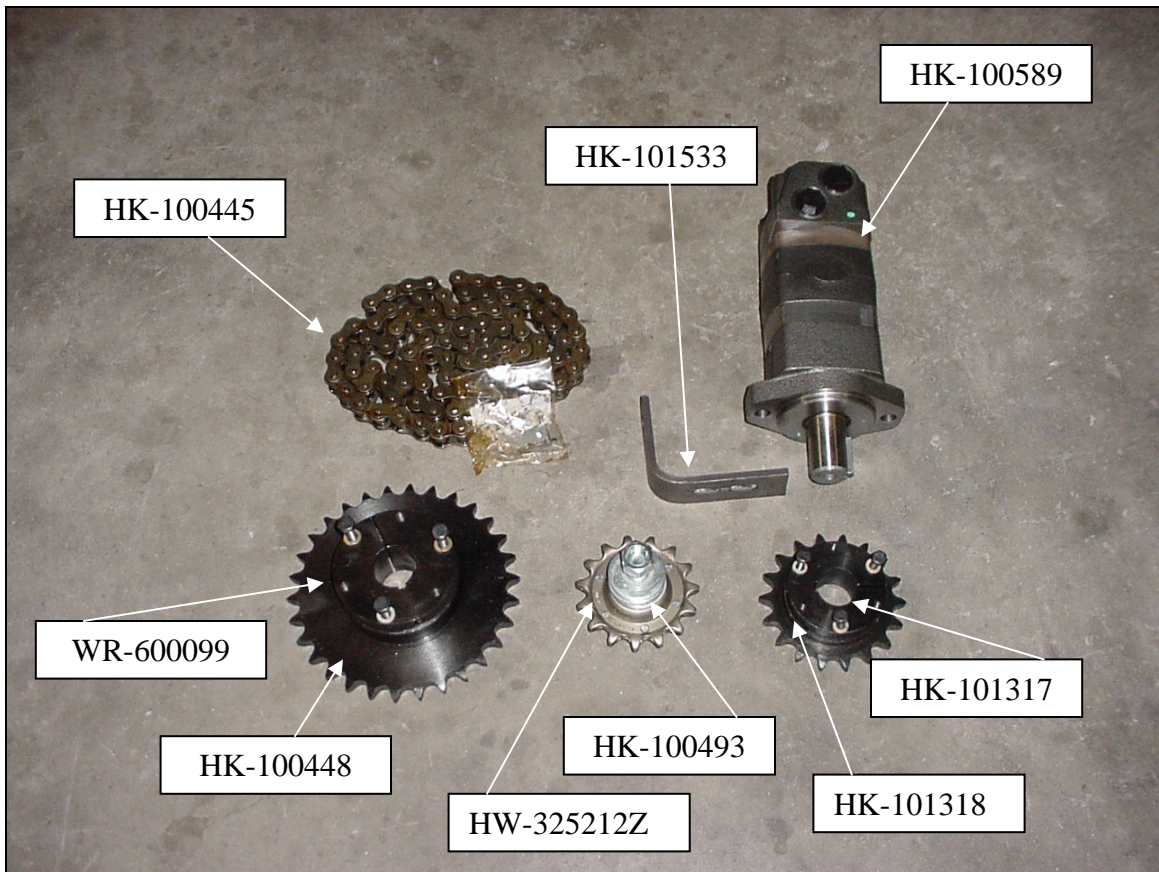

**Cylinder Motor & Parts**

|            |                               |
|------------|-------------------------------|
| HK-100445  | Chain, #60 Roller, 95 Pitches |
| HK-101533  | Guard Mount                   |
| HK-100589  | Cylinder Motor                |
| HK-101317  | Sprocket, 60 SDS 18H          |
| HK-101318  | Taper Bushing                 |
| HK-100493  | Idler                         |
| HW-325212Z | 5/8, USS, Flat Washer, ZP     |
| HK-100448  | Sprocket                      |
| WR-600099  | Bushing                       |

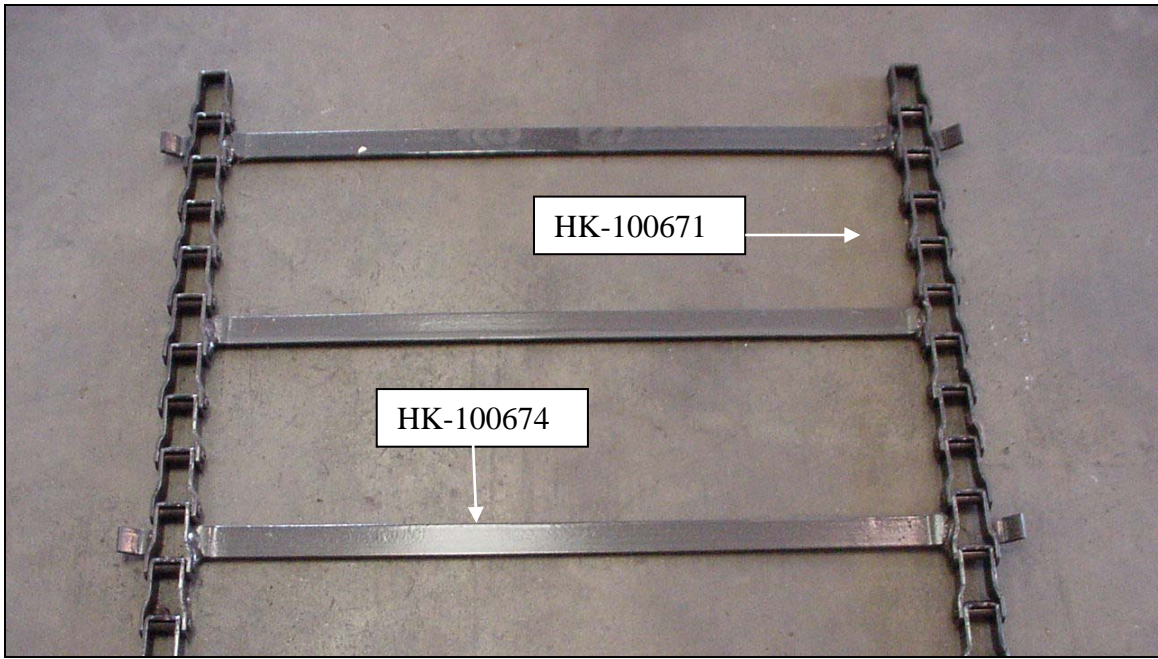

**Unloading Chain (HK-101296)**

|           |                    |
|-----------|--------------------|
| HK-100671 | Chain Link         |
| HK-100674 | Unloading Bar Assy |

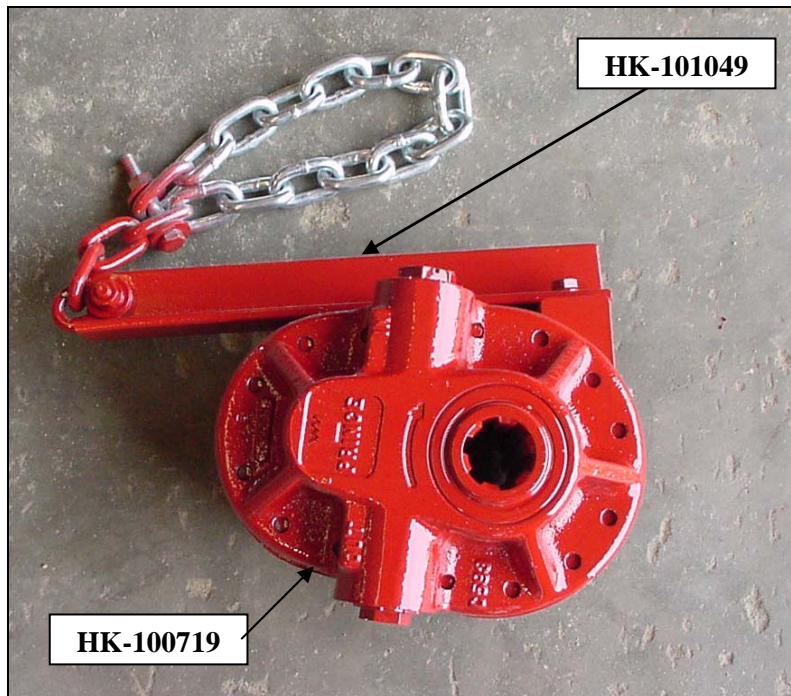

**PTO Pump Kit (HK-101330)**

| Part Number | Description         | Quantity |
|-------------|---------------------|----------|
| HK-101049   | Torque Arm Weldment | 1        |
| HK-100719   | Pump                | 1        |

## Fittings and Adapters



| #  | PART #    | DESCRIPTION        | #  | PART #    | DESCRIPTION         |
|----|-----------|--------------------|----|-----------|---------------------|
| 1  | HK-101762 | 90° HYD. ELBOW     | 2  | HK-101578 | 90° HYD. ELBOW      |
| 3  | HK-101760 | 45° HYD. ELBOW     | 4  | HK-101713 | HYD. ADAPTER        |
| 5  | HK-101759 | HYD. ADAPTER       | 6  | HK-101574 | HYD. ADAPTER        |
| 7  | HK-100972 | 90° HYD. ADAPTER   | 8  | HK-101642 | 90° HYD. ELBOW      |
| 9  | HK-101633 | 90° HYD. ELBOW     | 10 | HK-100974 | PORT ADAPTER        |
| 11 | HK-101763 | SWIVEL ADAPTER     | 12 | HK-100978 | HYD. ADAPTER        |
| 13 | HK-101761 | 90° HYD. ELBOW     | 14 | HK-100970 | 90° HYD. ELBOW      |
| 15 | HK-101582 | 90° HYD. ELBOW     | 16 | HK-101572 | HYD. ADAPTER        |
| 17 | HK-101721 | SWIVEL ADAPTER     | 18 | HK-101754 | REDUCER             |
| 19 | HK-101755 | REDUCER            | 20 | HK-101718 | 90° HYD. ELBOW      |
| 21 | HK-101757 | 45° HYD. ELBOW     | 22 | HK-101764 | 90° HYD. ADAPTER    |
| 23 | HK-100966 | QUICK COUPLER KIT  | 24 | HK-100776 | 1-1/4 NIPPLE        |
| 25 | HK-100963 | 1/2 NIPPLE         | 26 | HK-101439 | BUSHING             |
| 27 | HK-101756 | TEE                | 28 | HK-101765 | ¾ HYD. TEE          |
| 29 | HK-101758 | 90° HYD. ELBOW     | 30 | HK-101634 | ¾ HYD. TEE          |
| 31 | HK-100976 | 1/2 HYD. TEE       | 32 | HK-101711 | ½ HYD. TEE          |
| 33 | HK-100994 | CAP, QUICK CONNECT | 34 | HK-100993 | PLUG, QUICK CONNECT |

## Hydraulic Hoses

|           |                                 |
|-----------|---------------------------------|
| HK-101740 | 4AX - 6FJ - 4MPX - 50"          |
| HK-101568 | 6AX - 6FJX - 6FJX - 218"        |
| HK-101741 | 8AX - 8MP - 8FJ - 47"           |
| HK-101743 | 8AX - 8FJ - 8FJ - 23"           |
| HK-101746 | 8AX - 8FJ - 8FJ - 20"           |
| HK-101747 | 8AX - 8FJ - 8MPX - 23"          |
| HK-101748 | 12EX - 12FJ - 12FJ - 92"        |
| HK-101749 | 12EX - 12FJ - 12MJ - 192"       |
| HK-101750 | 12EX - 12FJ - 12FJ - 276"       |
| HK-101570 | 12SN - 12FJX - 12MS - 96"       |
| HK-101751 | 12EX - 12FJ - 12FJ - 72"        |
| HK-100980 | 20C - 20MP - 20MP - 108"        |
| HK-101564 | 12SN - 12FJX90 - 12FJX90 - 105" |
| HK-101565 | 12SN - 12FJX90 - 12MJ - 145"    |
| HK-101744 | 8AX - 12FJ - 8MPX - 42"         |
| HK-101745 | 8AX - 8MPX - 8FJ - 94"          |

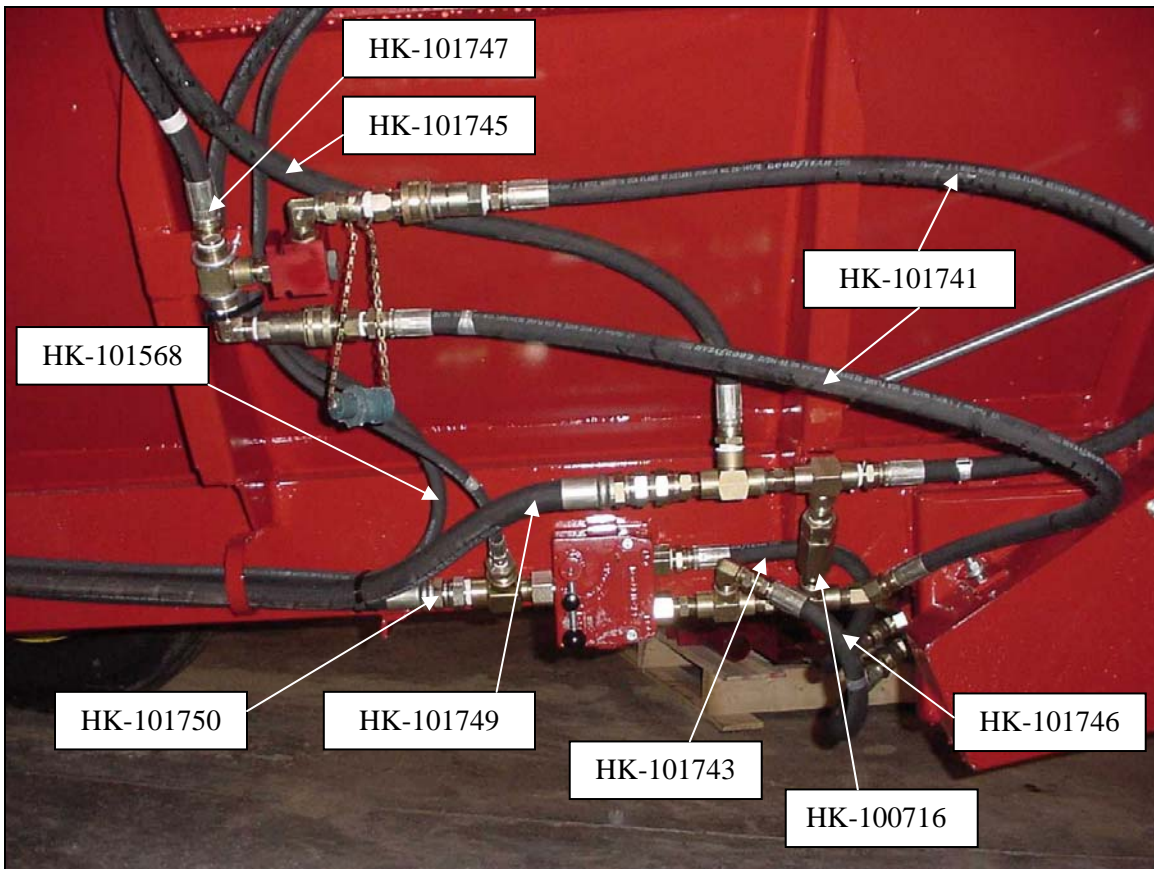



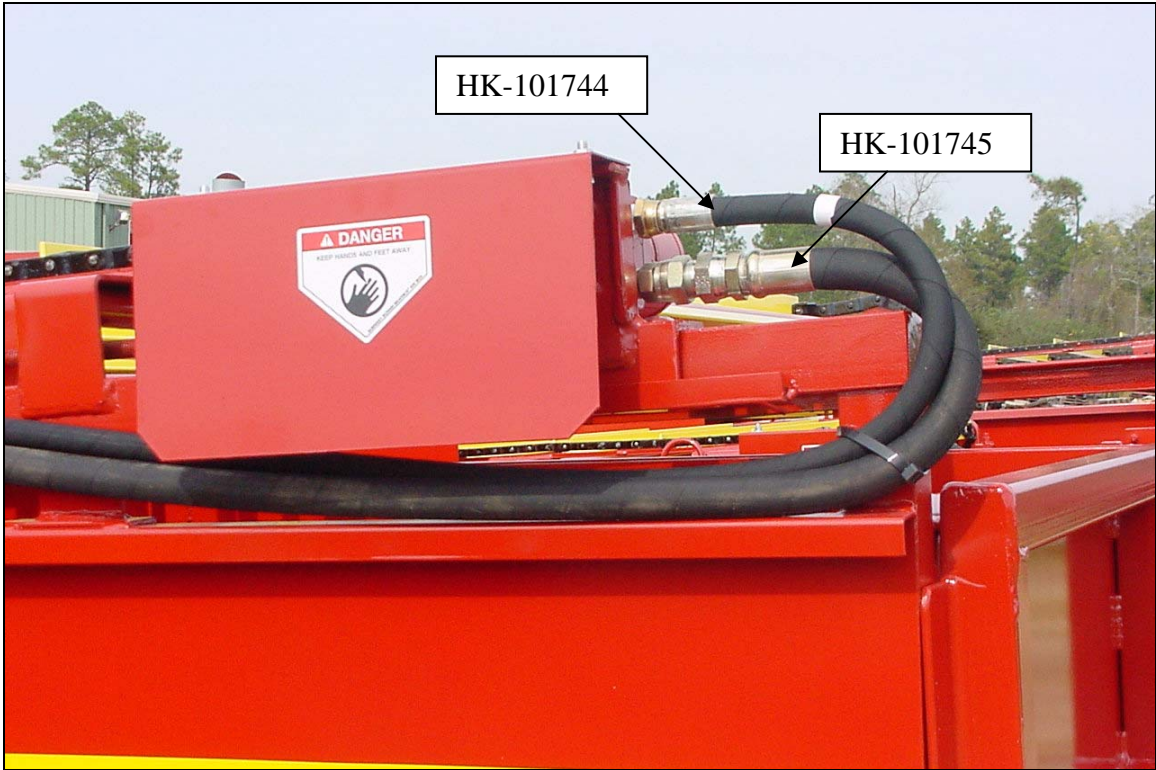

**Leveling Motor Hose Assembly**

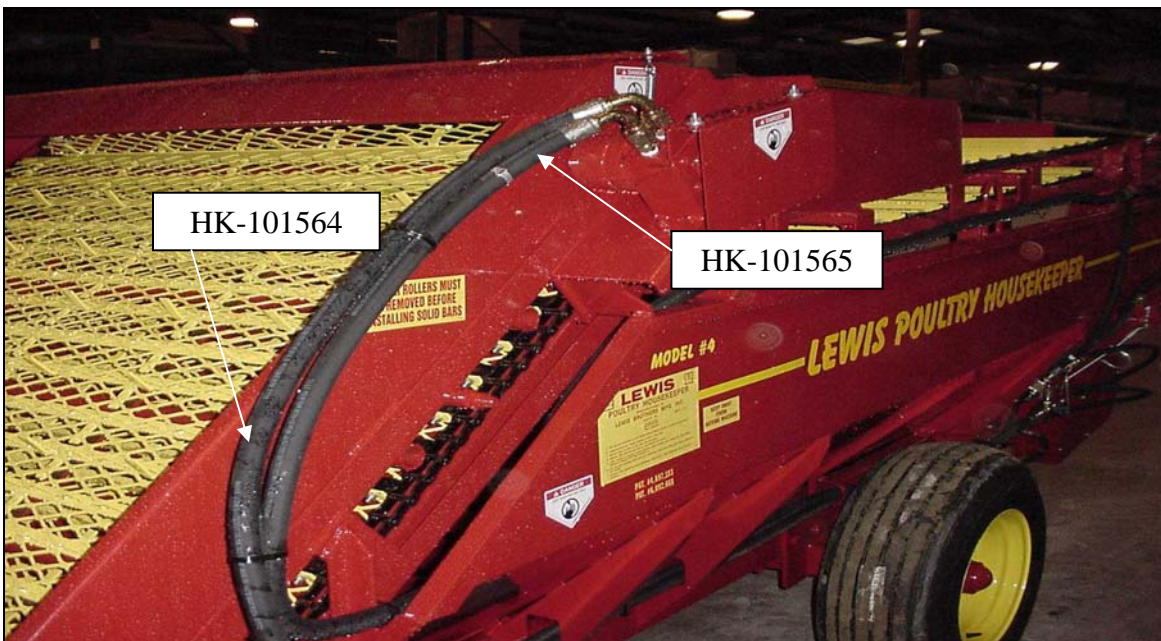

**Loading Motor Hose Assembly**

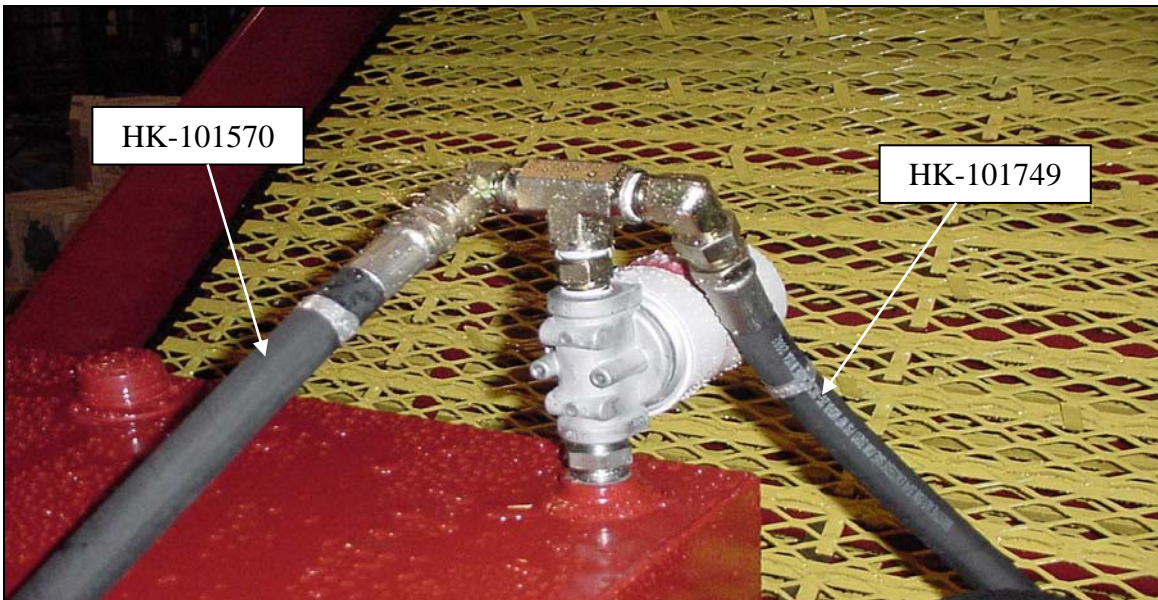
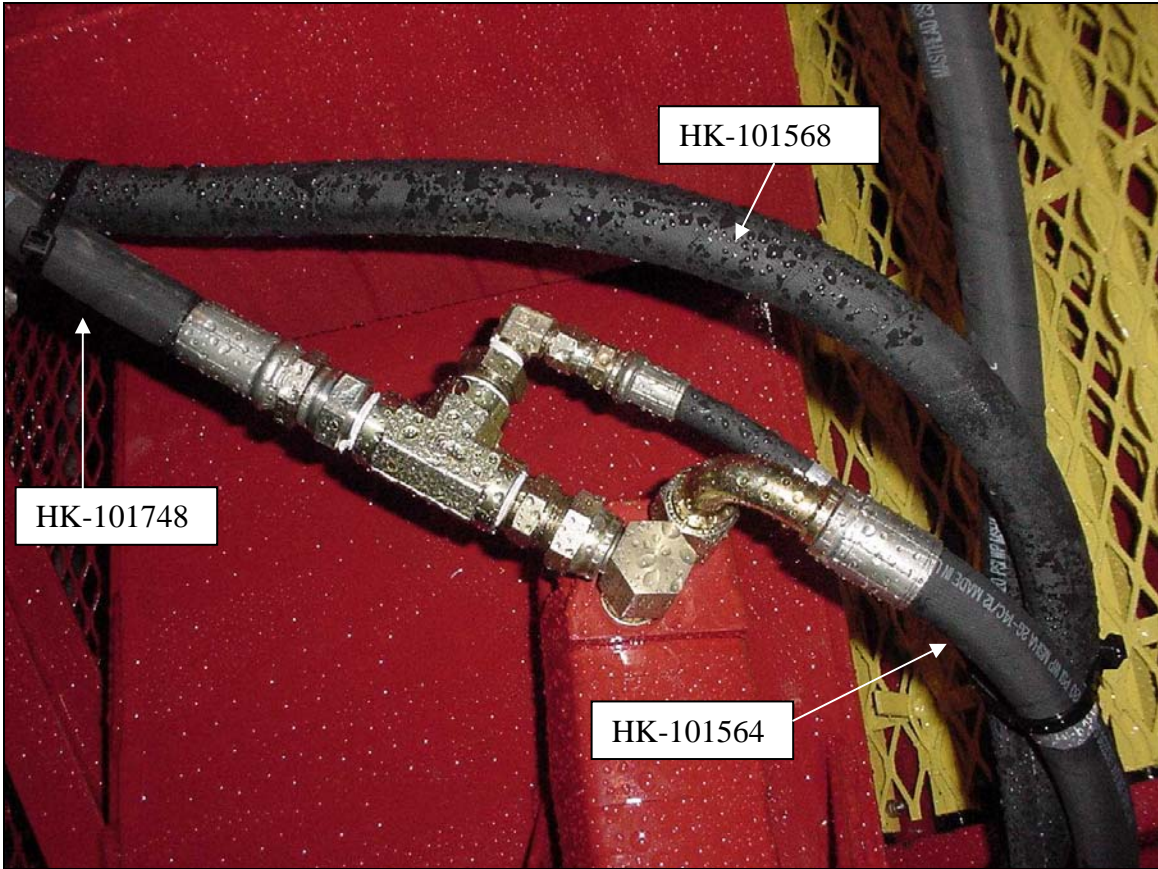

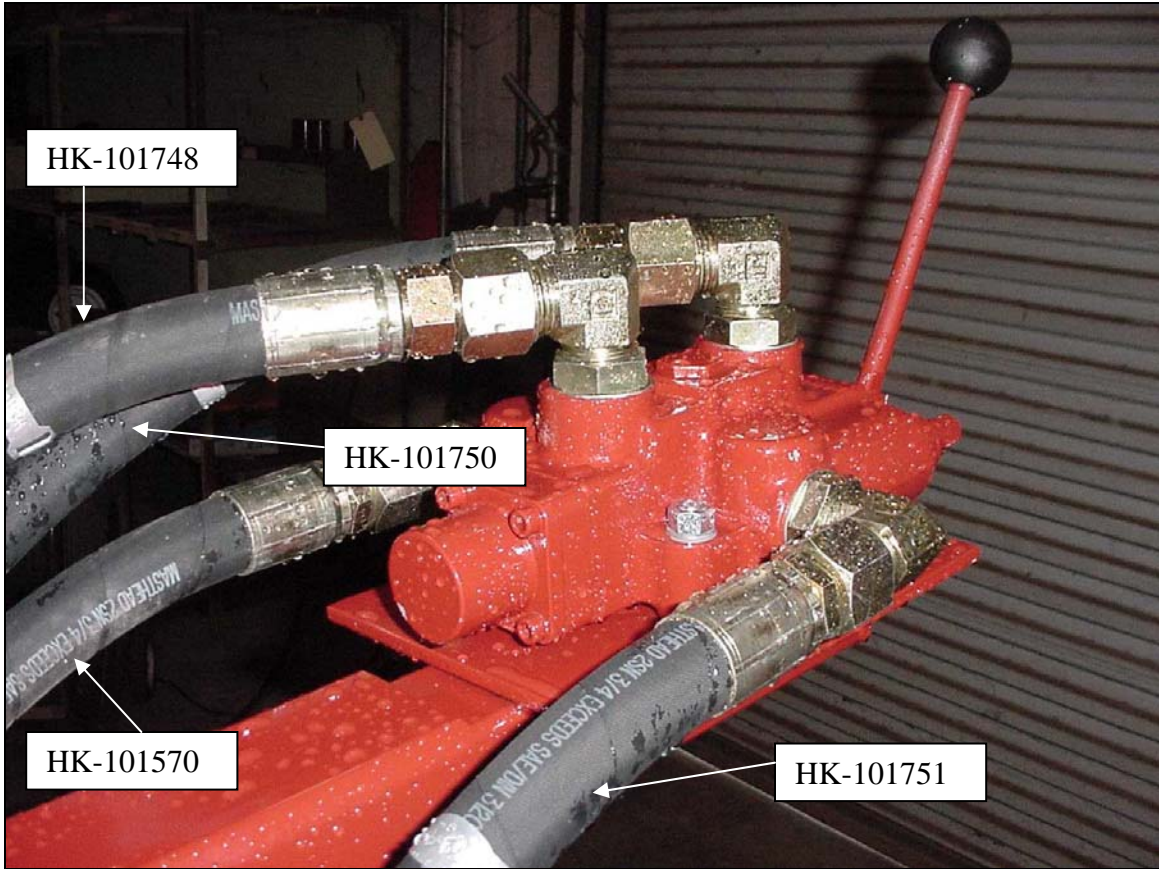

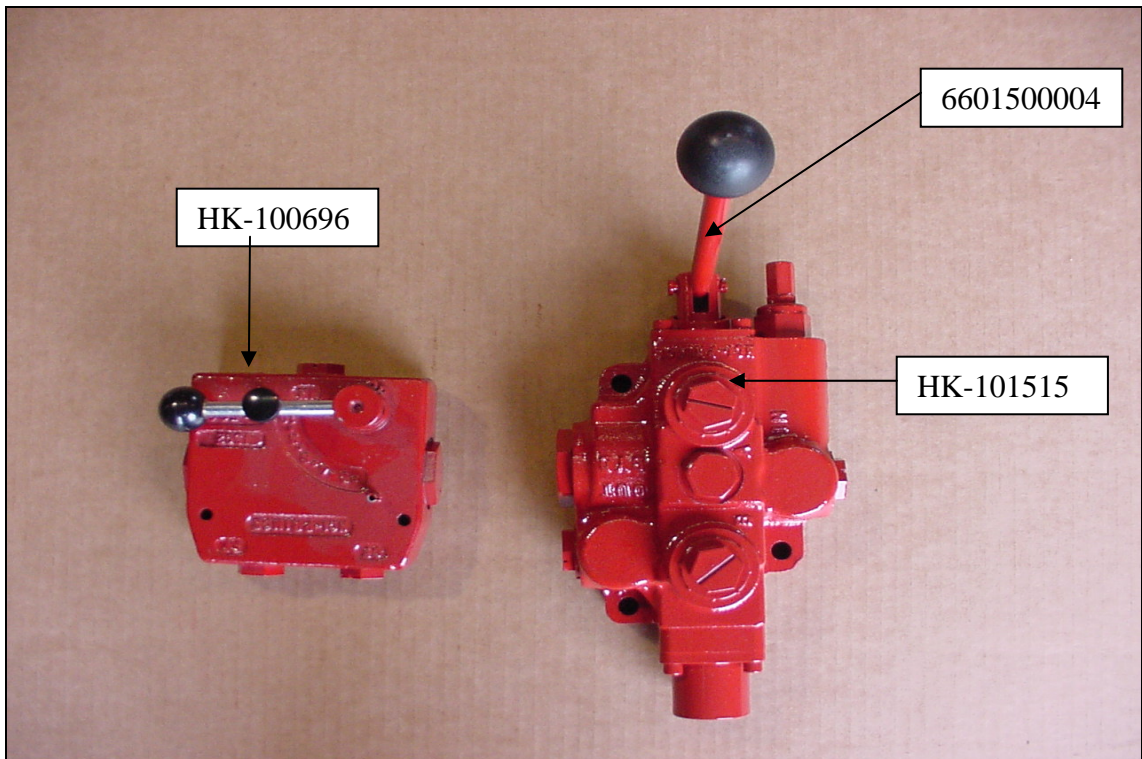
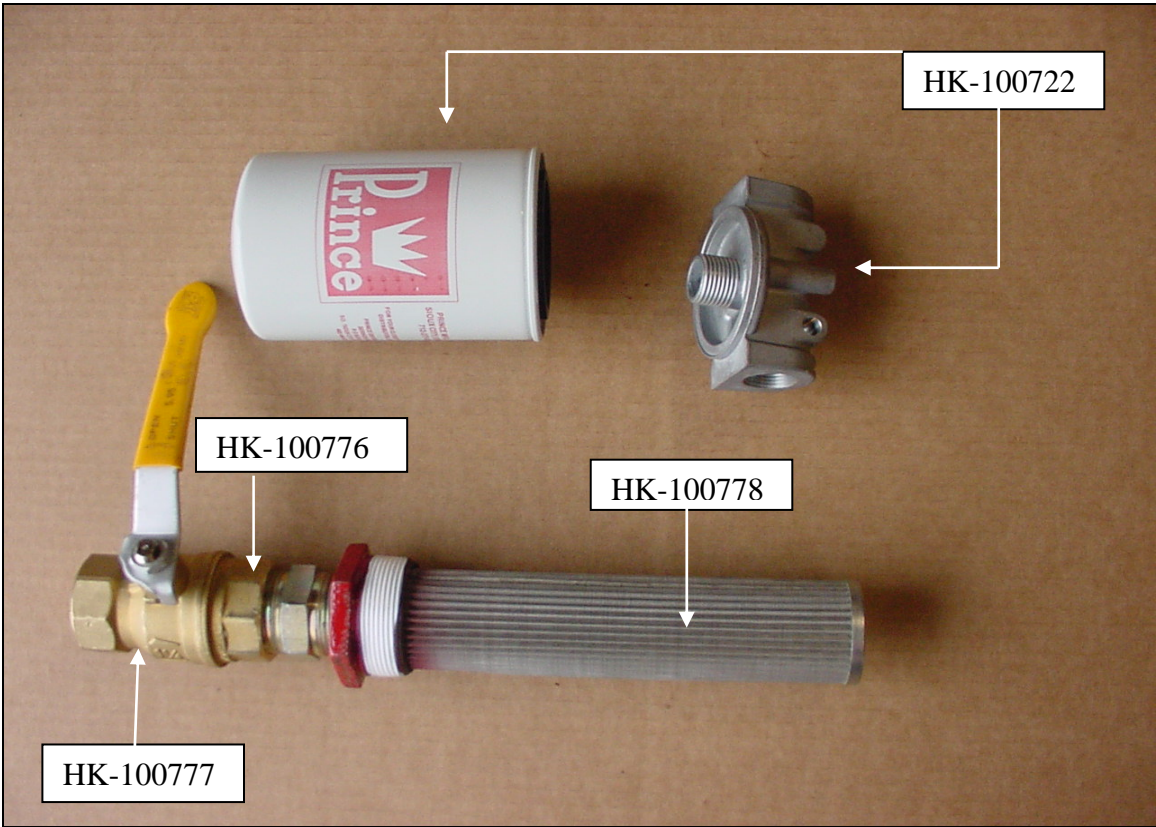

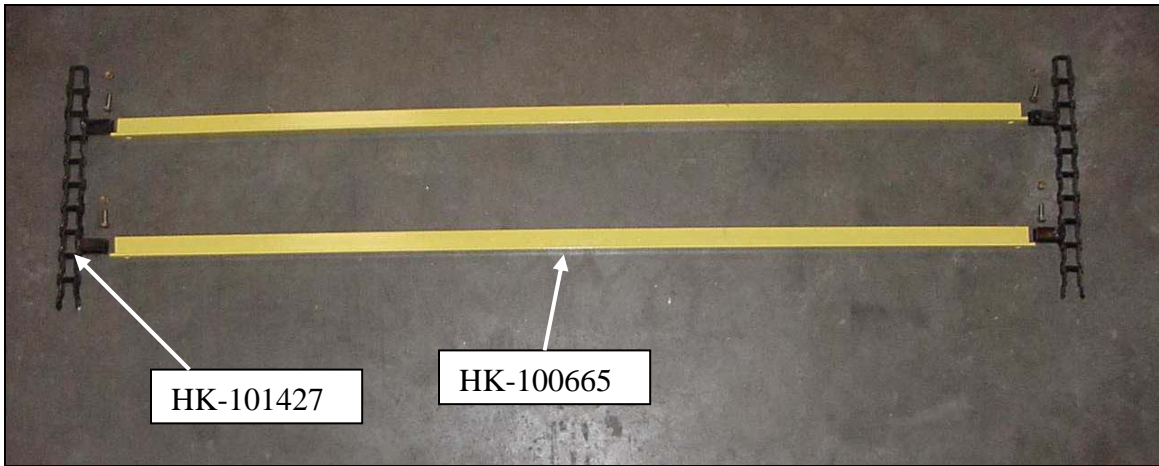

**Leveling Chain Assembly**

|               |                |
|---------------|----------------|
| HK-101427     | Leveling Chain |
| HK-100665     | Bar            |
| HW-301205L9   | Nut            |
| HW-205104L9YZ | Bolt           |

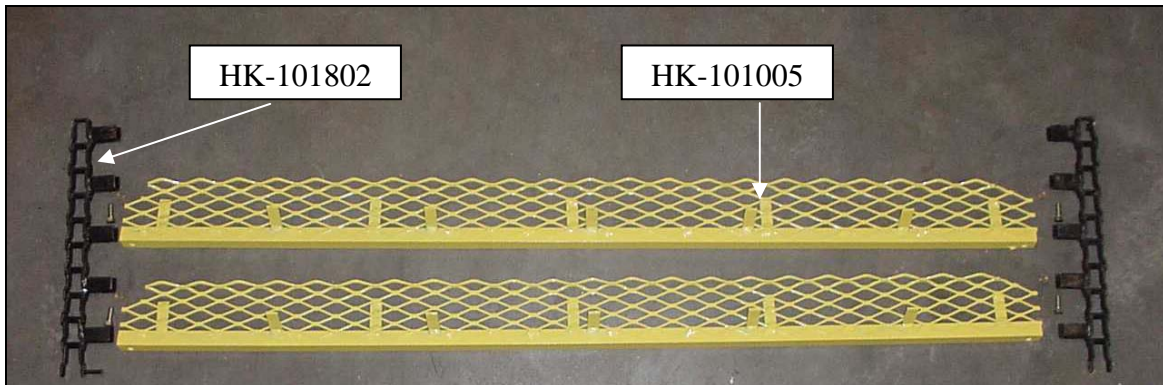

**Loading Chain Assembly**

| Part #           | Description                                 | Quantity    |
|------------------|---|-------------|
| HK-101802        | Loading Chain Complete w/ Bolts (serial # ) | 1           |
| <b>HK-101006</b> | <b>1" Shaker Bar Kit Complete</b>           | <b>1</b>    |
| HK-101003        | 1" Mesh Shaker Bar (No Peg)                 | 22          |
| HK-101004        | 1" Mesh Shaker Bar (5 Peg)                  | 11          |
| HK-101005        | 1" Mesh Shaker Bar (6 Peg)                  | 11          |
| <b>HK-101013</b> | <b>1-1/2" Shaker Bar Kit Complete</b>       | <b>1</b>    |
| HK-101001        | 1-1/2" Mesh Shaker Bar (No Peg)             | 22          |
| HK-101268        | 1-1/2" Mesh Shaker Bar (5 Peg)              | 11          |
| HK-101269        | 1-1/2" Mesh Shaker Bar (6 Peg)              | 11          |
| <b>HK-101531</b> | <b>Solid Bar Kit (not shown)</b>            | <b>1</b>    |
| HK-101548        | Solid Bar (not shown)                       | 44          |
| HK-101798        | Bar Attachment Link RH & LH                 | Repair Part |

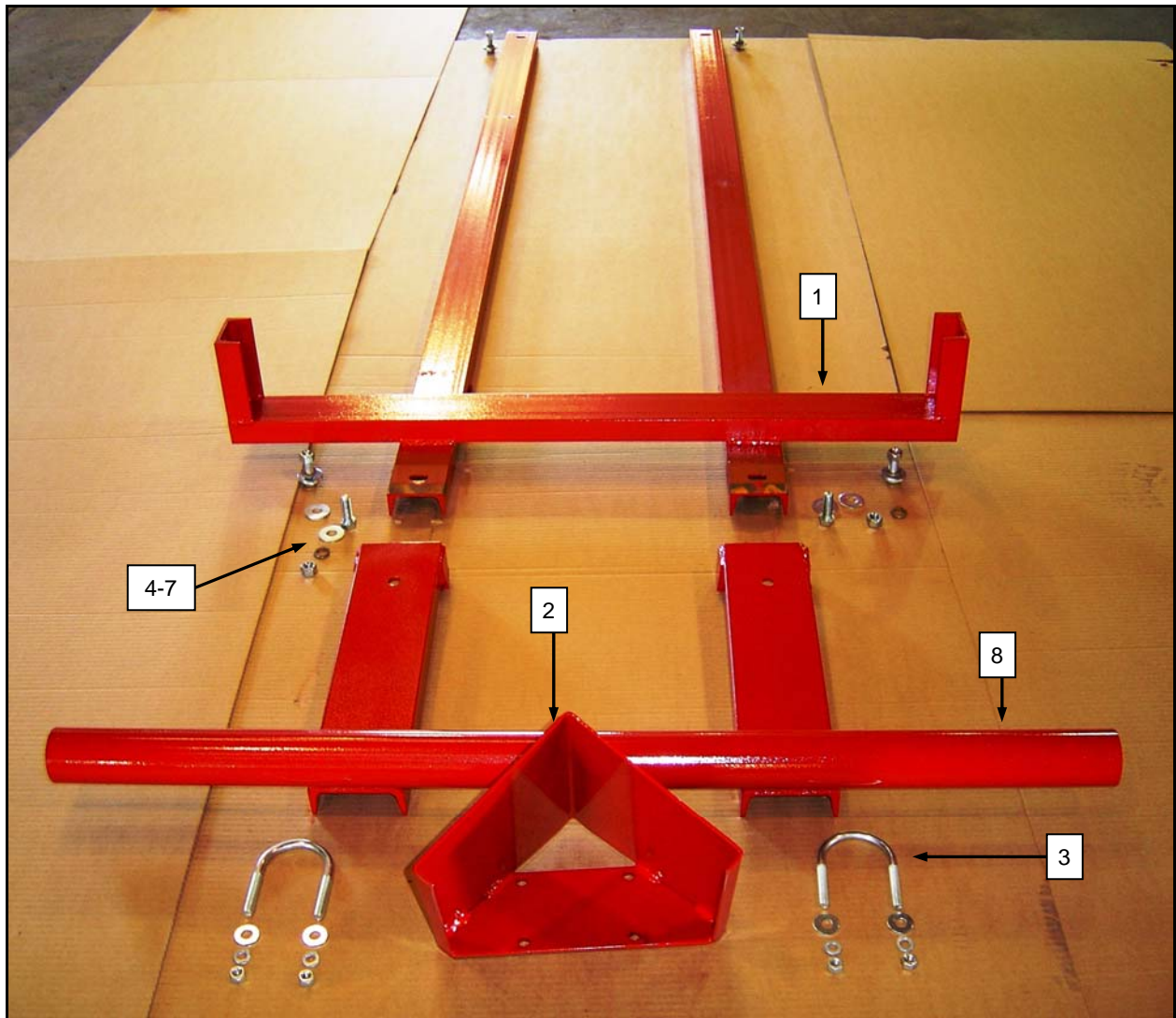

**Spinner Bumper Assembly**

| Ref. | Part #       | Description                           |
|------|--------------|---------------------------------------|
| 1    | HK-101817    | Bumper, Front                         |
| 2    | HK-100015    | Flow Divider Weldment                 |
| 3    | SP-200115    | U-Bolt                                |
| 4    | HW-208108G5Z | Bolt, HH, Sp, 1/2"-13nc x 1-1/2", Gr5 |
| 5    | HW-325208Z   | Washer, Flat, 1/2" ZP USS Std         |
| 6    | HW-335208Z   | Washer, Lock, 1/2" ZP                 |
| 7    | HW-300208ZG5 | Nut, Hex, 1/2"-13nc , ZP              |
| 8    | HK-101818    | Bumper, Rear                          |



## Full Load Indicator Kit

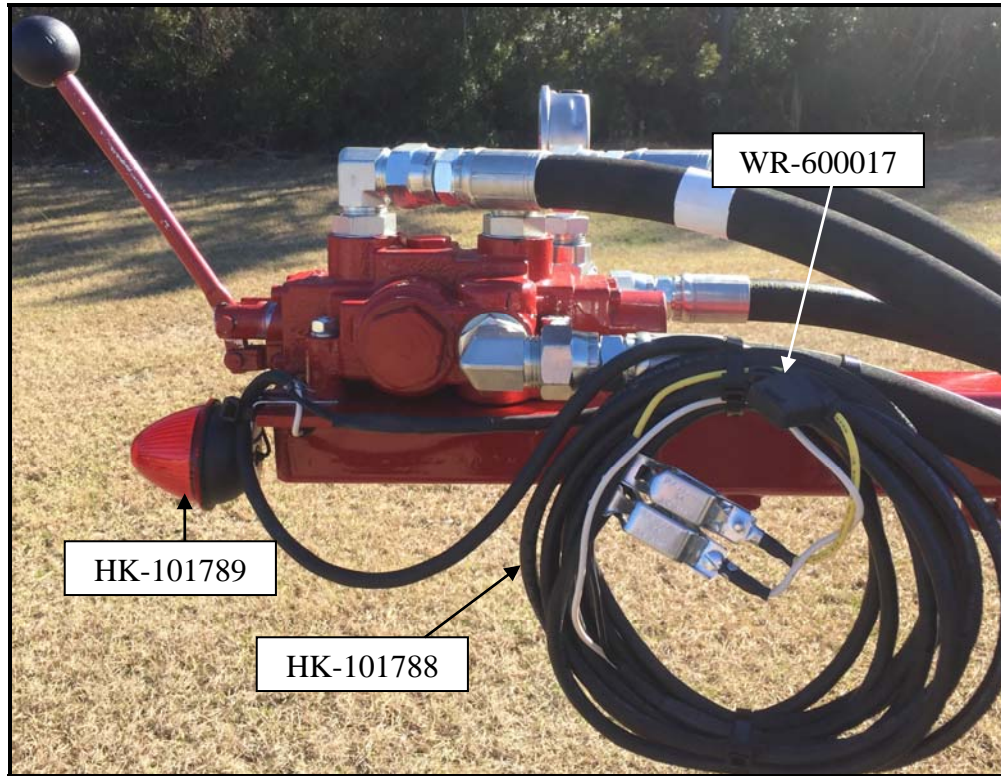

| Part Number      | Description   |
|------------------|---|
| <b>HK-101794</b> | <b>Full Load Indicator Kit</b>                      |
| HK-101791        | Insulated Ring Terminals                            |
| HK-101788        | Electrical Cable 16/2 sjow Type                     |
| HK-101793        | Momentary Push Button Switch                        |
| Hk-101789        | Light   |
| HK-101792        | Non Strip Splicer                                   |
| WR-600017        | Fuse Holder   |
| HW-208108SS      | Bolt, HH, 1/2-13NC x 1-1/2" LG 18-8 Stainless Steel |
| HW-300208ZG5     | Nut, Hex, 1/2-13NC Zinc Plated, Gr5                 |
| HK-101872        | Alligator Clip                                      |
| <b>HK-101787</b> | <b>Switch Activator Weldment</b>                    |



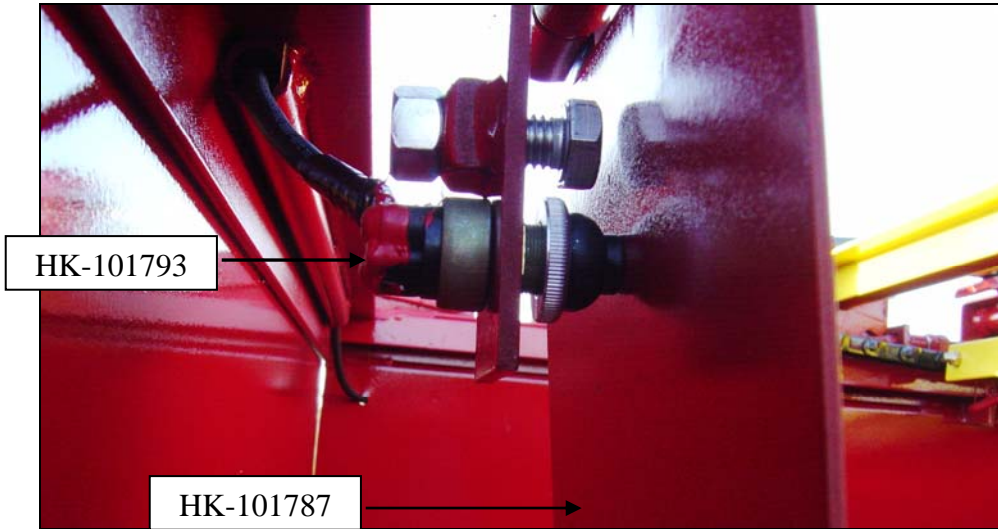

**Optional**

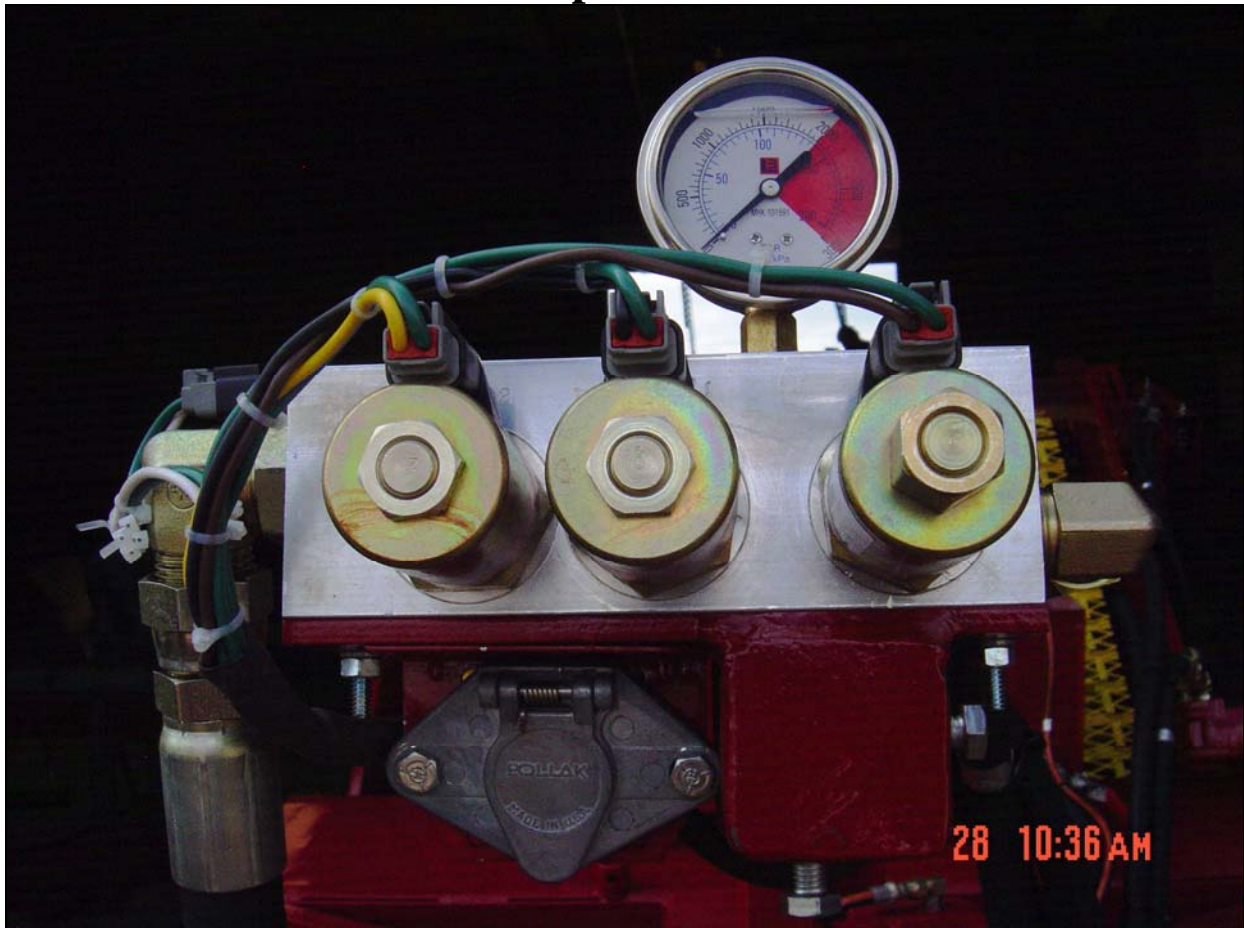

**Electric Control Valve Kit**

**HK-101738**

# ELECTRICAL SCHEMATIC

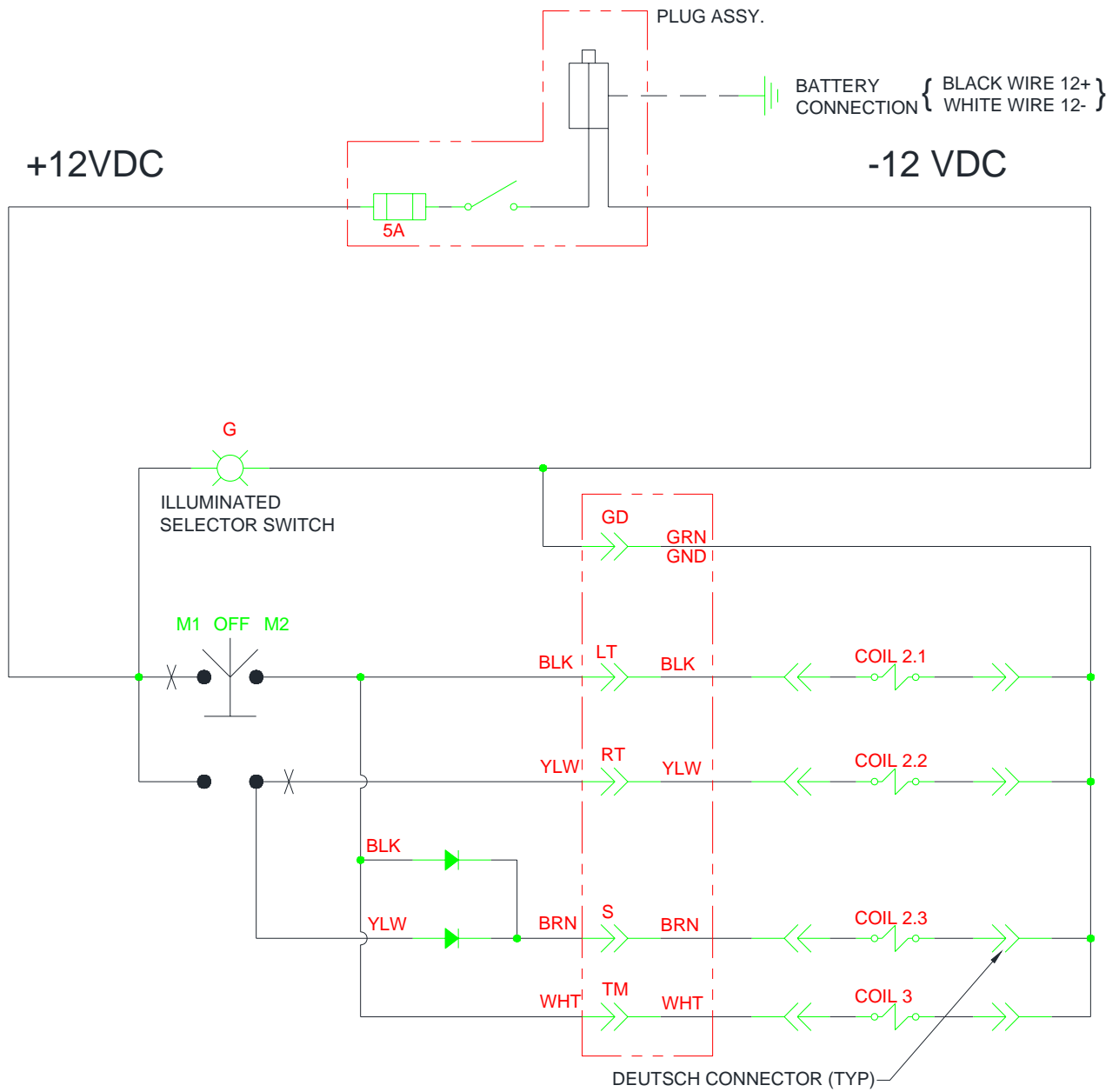

|                          |             |
|--------------------------|-------------|
| DWG NO. <b>HK-101731</b> |             |
| REV.                     | DESCRIPTION |
| DATE                     | APVD        |

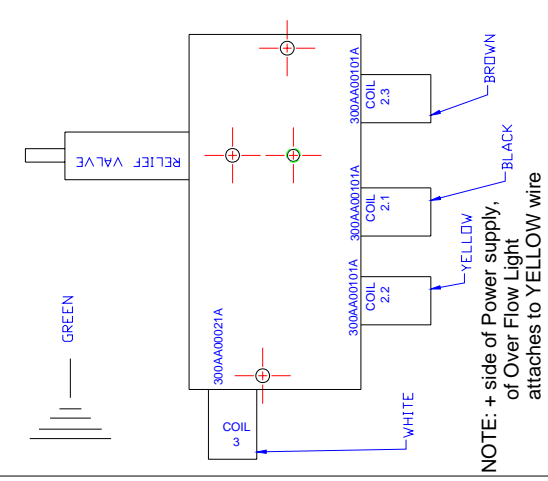
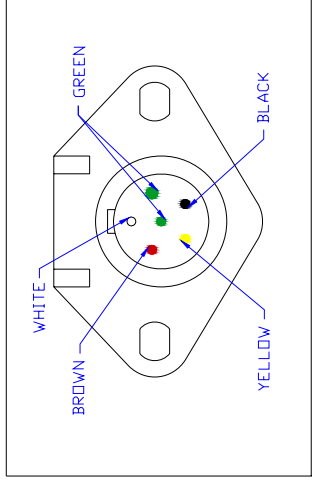
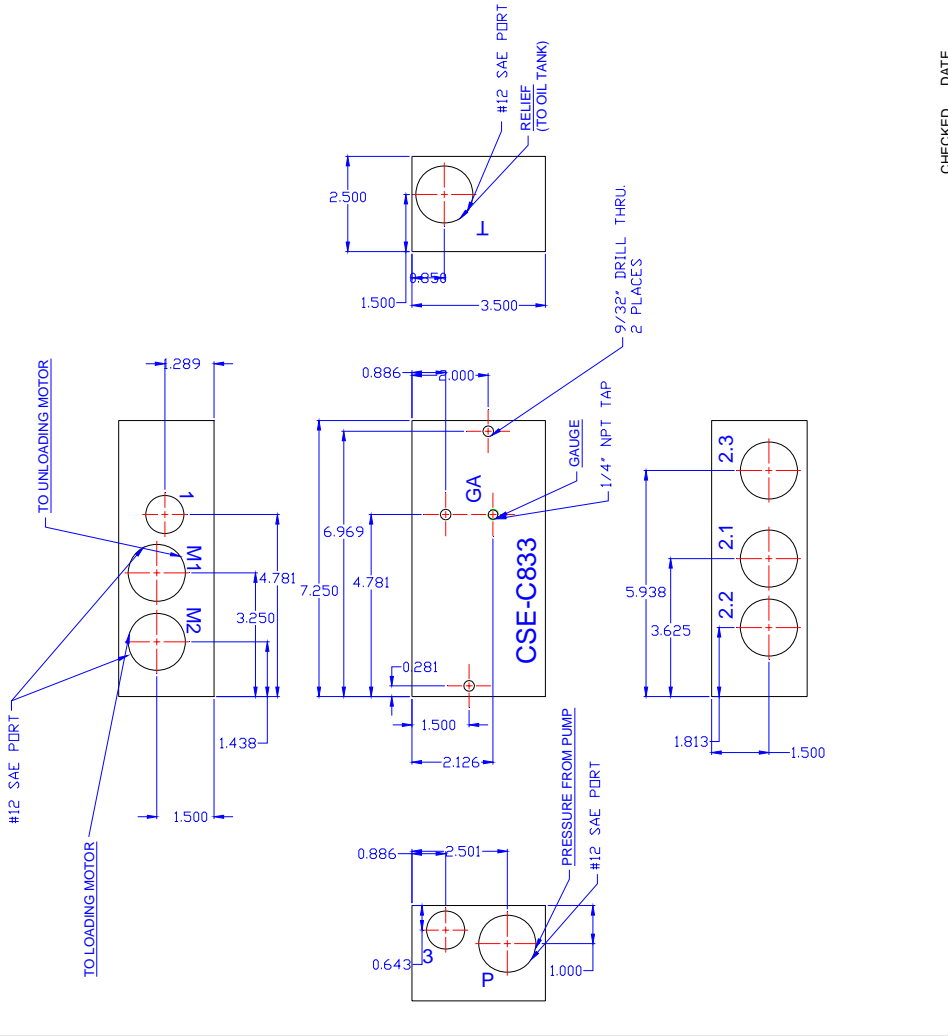

|  |  |                                     |
|--|--|-------------------------------------|
| DO NOT SCALE DRAWING<br>UNLESS OTHERWISE SPECIFIES DIMENSIONS<br>ARE IN INCHES TOLERANCES ARE:<br>FRACTIONAL: $\frac{1}{16}$ DECIMAL: _____<br>ANGLES: # 2 DEGREE  |  | CHECKED DATE<br><b>R.M.</b> 9-22-05 |
| PROPRIETARY DRAWING<br>This drawing cover a proprietary item and is the property of<br>Lewis Brothers Manufacturing, INC.. This drawing in not to be copied<br>or used without the approval of Lewis Brothers Manufacturing, INC.. |  | APPROVED DATE                       |
| 1 RV5-10-S-0-35/35, RELIEF EATON   |  |                                     |
| 2.1 SV1-16-C-0-12DG, VALVE EATON   |  |                                     |
| 2.2 SV1-16-C-0-12DG, VALVE EATON   |  |                                     |
| 2.3 SV3-16-0-0-12DG, VALVE EATON   |  |                                     |
| 3 SV5-8-0-12DGS, VALVE EATON   |  |                                     |
| MATERIAL   |  |                                     |

**Lewis Brothers Manufacturing, Inc.,**  
Baxley, Ga. - U.S.A.

Size A  
Scale-None  
Drawing 1 of 1

Drawn RLM  
Date 9-12-05

Drawing **HK-101731** SINGLE  
SPOOL ELECTRIC VALVE